

imaWorx CXP-12 Quad

Applet Feature Reference Manual for
Acq_DualCXP12Line

Functional Description
For pylon or GenTL Usage

Document Number: AW001748
Part Number: 000 (English)
Document Version: 03
Release Date: 22 December 2023
Applet Version 2.4.8.0

Contacting Basler Support Worldwide

Europe, Middle East, Africa

Tel. +49 4102 463 515

support.europe@baslerweb.com

The Americas

Tel. +1 610 280 0171

support.usa@baslerweb.com

Asia-Pacific

Tel. +65 6367 1355

support.asia@baslerweb.com

Singapore

Tel. +65 6367 1355

support.asia@baslerweb.com

Taiwan

Tel. +886 3 558 3955

support.asia@baslerweb.com

China

Tel. +86 10 6295 2828

support.asia@baslerweb.com

Korea

Tel. +82 31 714 3114

support.asia@baslerweb.com

Japan

Tel. +81 3 6672 2333

support.asia@baslerweb.com

<https://www.baslerweb.com/en/sales-support/support-contact>

Supplemental Information

Acquisition Card Documentation:

<https://docs.baslerweb.com/acquisition-cards>

Frame Grabber Documentation:

<https://docs.baslerweb.com/frame-grabbers>

Framegrabber SDK Documentation:

<https://docs.baslerweb.com/frame-grabbers/framegrabber-sdk-overview.html>

All material in this publication is subject to change without notice and is copyright Basler AG.

Table of Contents

1. Introduction	1
1.1. Features of Applet Acq_DualCXP12Line	1
1.1.1. Parameterization Order	2
1.2. Bandwidth	3
1.3. Requirements	3
1.3.1. Software Requirements	3
1.3.2. Hardware Requirements	4
1.3.3. License	4
1.4. Camera Interface	4
1.5. Frame ID	4
1.6. Image Transfer to PC Memory	4
2. CoaXPress	5
2.1. PixelFormat	5
2.2. SystemmonitorUsedCxpConnections	6
2.3. PacketTagErrorCount	6
2.4. CorrectedErrorCount	6
2.5. UncorrectedErrorCount	7
2.6. SystemmonitorPacketbufferOverflowCount	7
2.7. SystemmonitorPacketbufferOverflowSource	8
2.8. SystemmonitorCxpImageLineMode	8
3. Camera	9
3.1. CameraEvents	9
3.1.1. FrameTransferStart	9
3.1.2. FrameTransferEnd	9
3.1.3. LineTransferStart	9
3.1.4. LineTransferEnd	9
4. SensorGeometry	10
4.1. VantagePoint	10
4.2. SensorWidth	10
4.3. SensorHeight	11
5. ROI	12
5.1. Width	13
5.2. Height	14
5.3. OffsetX	14
5.4. OffsetY	15
6. DigitalIO	16
6.1. CameraTriggerSource	16
6.1.1. CxpLinkTrigger0Source	16
6.1.2. CxpLinkTrigger0SourceEdge	17
6.1.3. CxpLinkTrigger1Source	18
6.1.4. CxpLinkTrigger1SourceEdge	18
6.1.5. CxpLinkTrigger2Source	19
6.1.6. CxpLinkTrigger2SourceEdge	20
6.1.7. CxpLinkTrigger3Source	20
6.1.8. CxpLinkTrigger3SourceEdge	21
6.2. GPO	22
6.2.1. TriggerOutGPO0Source et al.	22
6.2.2. TriggerOutGPO0Polarity et al.	23
6.2.3. TriggerOutFrontGPO0Source et al.	23
6.2.4. TriggerFrontOutGPO0Polarity et al.	24
6.3. GPIState	25
6.3.1. DigitalInput	25
6.4. EventSource	25
6.4.1. CustomSignalEvent0Source	25
6.4.2. CustomSignalEvent0Polarity	26
6.4.3. CustomSignalEvent1Source	27

6.4.4. CustomSignalEvent1Polarity	28
6.5. Events	29
6.5.1. Line0RisingEdge	29
6.5.2. Line0FallingEdge	29
6.5.3. CustomSignalEvent0	29
6.5.4. CustomSignalEvent1	29
7. LineTriggerExSync	30
7.1. LineTriggerMode	30
7.2. ExSyncOn	31
7.3. LineTriggerInput	32
7.3.1. LineTriggerInSource	33
7.3.2. LineTriggerInPolarity	34
7.3.3. LineTriggerDebouncing	34
7.3.4. Downscale	35
7.3.4.1. LineDownscale	35
7.3.4.2. LineDownscaleInIt	36
7.4. ShaftEncoderABFilter	36
7.4.1. ShaftEncoderOn	37
7.4.2. ShaftEncoderMode	37
7.4.3. ShaftEncoderInputSource	38
7.4.4. ShaftEncoderLeading	39
7.4.5. ShaftEncoderCompensationEnable	40
7.4.6. ShaftEncoderCompensationCount	41
7.5. ExSyncOutput	46
7.5.1. LinePeriod	47
7.5.2. LineExposure	48
7.5.3. ExSyncPolarity	48
7.5.4. LineTriggerDelay	49
8. ImageTriggerFlash	50
8.1. ImageTriggerMode	51
8.2. ImageTriggerOn	51
8.3. FlashOn	52
8.4. ImageTriggerAsyncHeight	52
8.5. ImageTriggerIsBusy	52
8.6. ImageTriggerInput	53
8.6.1. ImageTriggerInputSource	53
8.6.2. ImageTriggerInputPolarity	54
8.6.3. ImageTriggerGateDelay	54
8.6.4. ImageTriggerDebouncing	54
8.6.5. StrobePulseDelay	55
8.6.6. Flash	55
8.6.6.1. FlashPolarity	55
8.6.7. SoftwareTrigger	56
8.6.7.1. SendSoftwareTrigger	56
8.6.7.2. SetSoftwareTrigger	56
9. SignalAnalyzer	58
9.1. SignalAnalyzer0Source et al.	58
9.2. SignalAnalyzer0Polarity et al.	59
9.3. SignalAnalyzer0CurrentPeriod et al.	60
9.4. SignalAnalyzer0MaxPeriod et al.	60
9.5. SignalAnalyzer0MinPeriod et al.	61
9.6. SignalAnalyzer0PulseCount et al.	61
9.7. SignalAnalyzerPulseCountDifference	62
9.8. SignalAnalyzerClear	62
10. BufferStatus	64
10.1. FillLevel	64
10.2. Overflow	65
10.3. OverflowOffThreshold	65

Table of Contents

10.4. OverflowOnThreshold	66
10.5. OverflowSyncOnThreshold	66
10.6. OverflowEventSelect	66
10.7. OverflowEvents	67
10.7.1. Overflow	68
11. ImageSelector	69
11.1. ImageSelectPeriod	69
11.2. ImageSelect	69
12. WhiteBalance	71
12.1. ScalingFactorGreen	71
12.2. ScalingFactorRed	71
12.3. ScalingFactorBlue	71
13. ColorConverter	73
14. LookupTable	74
14.1. LutEnable	74
14.2. LutType	74
14.3. LutValue	75
14.4. LutValueRed	76
14.5. LutValueGreen	76
14.6. LutValueBlue	76
14.7. LutCustomFile	77
14.8. LutSaveFile	79
14.9. AppletProperties	79
14.9.1. LutImplementationType	79
14.9.2. LutInputPixelBitDepth	79
14.9.3. LutOutputPixelBitDepth	80
15. Processing	81
15.1. ProcessingOffset	81
15.2. ProcessingGain	82
15.3. ProcessingGamma	83
15.4. ProcessingInvert	84
16. OutputFormat	85
16.1. Format	85
16.2. BitAlignment	88
16.3. PixelDepth	89
16.4. CustomBitShiftRight	89
17. Revision History	91
17.1. Fixed Issues	91
17.1.1. Fixed in Version 2.4.8.0	91
17.1.2. Fixed in Version 2.3.8.0	92
17.1.3. Fixed in Version 2.0.4.0	92
17.2. Known Issues	92
Glossary	93
Index	96

Chapter 1. Introduction

This document provides you with detailed information on applet "Acq_DualCXP12Line" for imaWorx CXP-12 Quad frame grabber.



In the following, you will find a full description of the applet's functionality and features.

For information on the hardware or for a general introduction on how to configure the CXP-12 Interface Card using the pylon API, the pylon Viewer, or the gpioTool check the document which can be found in <https://docs.baslerweb.com/pc-cards>.

All applet-specific parameters described in this document are as represented in the GenTL interface.

For a general explanation of the GenTL interface, check the Basler GenTL interface documentation (<https://www.baslerweb.com/en/sales-support/downloads/document-downloads/cxp-gentl-producer-feature-documentation/>).

For information on camera features, check the respective camera documentation.

For information on Basler pylon features and for API documentation, check the pylon documentation.

1.1. Features of Applet Acq_DualCXP12Line

"Acq_DualCXP12Line" is a dual-camera applet. Up to two individual cameras can be used in parallel. All features of this applet are available for both camera ports. You can configure the CoaXPress camera interface for CoaXPress cameras version 1.1.1 and 2.0, transferring grayscale (monochrome) or color pixels. Allowed pixel formats are Gray (Mono8, Mono10, Mono12, Mono14, Mono16), Color (RGB8, RGB10, RGB12, RGB14, RGB16), and YCbCr422_8. You can use cameras with CoaXPress link aggregation of 2 and 1 with this applet. The maximum link speed is CXP-12. A multi-functional line trigger is included in the applet. This allows you to control the camera or external devices using frame grabber generated, external or software generated trigger pulses. Line scan cameras up to a width of 32768 pixels can be processed. The trigger system will generate images of a maximum height of 8388607 pixels. The applet is processing data at a bit depth of 16 bits. An image selector at the camera port facilitates the selection of one image out of a parameterizable sequence of images. This enables the distribution of the images to multiple frame grabber and PCs. For reverse operation, you can mirror the image in x-direction and y-direction before cutting the ROI. Acquired images are buffered in frame grabber memory. You can select a region of interest (ROI) for further processing. The stepsize of the ROI width is 16 pixel. The ROI stepsize for the image height is 1 line. A color converter automatically converts the input pixel formats to the output formats. In this applet conversions from monochrome, RGB to monochrome and RGB can be performed. You can configure the 14 bit full resolution lookup table either by using a user defined table, or by using a processor. The processor gives you the opportunity to use pre-defined functions such as offset, gain, invert to enhance the image quality. The color components are processed individually. A gamma correction is possible.

Processed image data are output by the applet via high speed DMA channels. You can select the pixel format of the output. The pixel format can either be 8 bit, 10 bit packed, 12 bit packed, 14 bit packed, or 16 bits per pixel (or per pixel component if you work with a color format).

Table 1.1. Feature Summary of Acq_DualCXP12Line

Feature	Applet Property
Applet Name	 Acq_DualCXP12Line
Type of Applet	AcquisitionApplets
Board	imaWorx CXP-12 Quad
No. of Cameras	2 , asynchronous or synchronous
Camera Type	CoaXPress, link aggregation max. 2, maximum speed CXP-12, Version 1.1.1 and 2.0
Sensor Type	Line Scan
Camera Format	Monochrome or RGB
Pixel Format	Gray (Mono8, Mono10, Mono12, Mono14, Mono16), Color (RGB8, RGB10, RGB12, RGB14, RGB16), and YCbCr422_8.
Processing Bit Depth	16 Bit per color component
Sensor Correction / Tap Sorting	no
Maximum Images Dimensions	32768 * 8388607
ROI Stepsize	x: 16, y: 1
Tap Geometry Sorting	1X-1Y only
Mirroring	Yes, horizontal and vertical (set the parameter <i>VantagePoint</i>)
Image Selector	Yes
Noise Filter	No
Shading Correction	No
Dead Pixel Interpolation	No
Bayer Filter	No
Color White Balancing	Yes
Color Converter	yes, Mono, RGB to Mono or RGB
Lookup Table	Full Resolution Input bits = 14, Output bits = 16 Lookup table can be disabled.
DMA	Full Speed
DMA Image Output Format	All grayscale and color formats. See description above.
Event Generation	yes
Overflow Control	yes

1.1.1. Parameterization Order

We recommend to configure the functional blocks which are responsible for sensor setup/correction first. This will be the camera settings, shading correction, and dead pixel interpolation (if available). Afterwards, you can

configure other image enhancement functional blocks such as white balancing, noise filter, and lookup table. By default, all presets are configured for receiving images directly.

1.2. Bandwidth

The maximum bandwidths of applet Acq_DualCXP12Line are listed in the following table.

Table 1.2. Bandwidth of Acq_DualCXP12Line

Description	Bandwidth
Max. CXP Speed	CXP-12
Peak Bandwidth per Camera	2400 MPixel/s
Mean Bandwidth per Camera	2400 MPixel/s
DMA Bandwidth	7200 MByte/s (depends on PC mainboard)

The peak bandwidth defines the maximum allowed bandwidth for each camera at the camera interface. If the camera's peak bandwidth is higher than the mean bandwidth, the frame grabber on-board buffer will fill up as the data can be buffered, but not be processed at that speed.

The mean bandwidth per camera describes the maximally allowed mean bandwidth for each camera at the camera interface. It is the product of the framerate and the image pixels. For example, with 1-megapixel images at a framerate of 100 frames per second, the mean bandwidth will be 100 MPixel/s. In case of 8bit per pixel as output format, this would be equal to 100 MB per second.

The required output bandwidth of an applet can differ from the input bandwidth. A region of interest (ROI) and the output format can change the required output bandwidth and the maximum mean bandwidth. Mind that the DMA bandwidth is the total bandwidth. The sum of all camera channel bandwidths has to be less than the maximum DMA bandwidth to avoid overflows.

Regard the relation between MPixel/s and MByte/s: The MByte/s depend on the applet and its parameterization concerning the pixel format. It is possible to acquire more than 8 bit per pixel or to convert from one bit depth to another. 1 MByte is 1,000,000 Byte.



Bandwidth Varies

The exact maximum DMA bandwidth depends on the used PC system and its chipset. The camera bandwidth depends on the image size and the selected frame rate. The given values of 7200 MByte/s for the possible DMA bandwidth might be lower due to the chipset and its configuration. Additionally, some PCIe slots do not support the required number of lanes to transfer the requested or expected bandwidth. In these cases, have a look at the mainboard specification. A behaviour like multiplexing between several PCIe slots can be seen in rare cases. Some mainboard manufacturers provide a BIOS feature where you can select the PCIe payload size: Always try to set this to its maximum value or simply to automatic. This can help in specific cases.

1.3. Requirements

In the following, the requirements on software, hardware and frame grabber license are listed.

1.3.1. Software Requirements

To run this applet, a supporting runtime environment is required. This can be either Basler pylon, or the Basler Framegrabber SDK providing the GenTL interface.

1.3.2. Hardware Requirements

To run applet "Acq_DualCXP12Line", a Basler imaWorx CXP-12 Quad frame grabber is required.

For PC system requirements, check the frame grabber hardware documentation. The applet itself does not require any additional PC system requirements.

1.3.3. License

This applet is of type AcquisitionApplets. For applets of this type, no license is required. All compatible frame grabbers can run the applet using the Basler Framegrabber SDK.

1.4. Camera Interface

Applet "Acq_DualCXP12Line" supports 2 CXP cameras. The frame grabber has 4 connectors. Use two or one CoaXPress cables to connect each of the cameras with the frame grabber. The maximum link aggregation of this applet is two. The mapping of the ports between the camera and the frame grabber is not important. You can chose any order.

Figure 1.1. Camera Interface and Camera Cable Setup

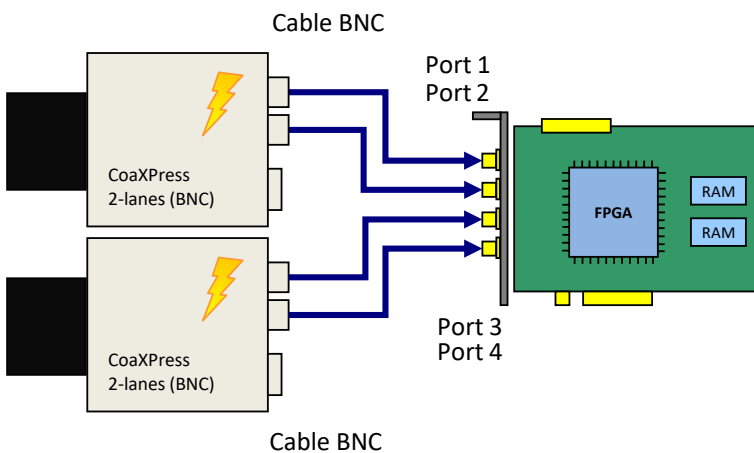

1.5. Frame ID

For CoaXPress linescan cameras the CXP Source Tag is not used as it is constant throughout the acquisition. Instead an internal counter is used to represent frame IDs. This applet will output each frame to the host PC attached with this frame ID. Moreover, overflow events will also include this frame ID. By this, the exact mapping of a given frame in the host PC to the frame the frame grabber's image trigger is possible.

Check chapter Chapter 10, '*BufferStatus*' for more information about overflow conditions and the overflow event data structure including the frame ID.

The frame ID is processed together with the images in the host PC. Check the Basler GenTL documentation to learn on how to extract the frame ID from the buffer.

1.6. Image Transfer to PC Memory

The image transfer between frame grabber and PC is performed via DMA transfers. In this applet, 2 DMA channels exist for transferring image data. One channel for each camera. The DMA channels have the same indices as the cameras, starting with 0. The applet output format can be set via the parameters of the output format module. See Chapter 16, '*OutputFormat*'. All outputs are little-endian coded.

Chapter 2. CoaXPress

This applet can be used with up to 2 line scan cameras. To receive correct image data from your camera, it is crucial that the camera output format matches the selected frame grabber input format. The following parameters configure the frame grabber's camera interface to match with the individual camera pixel format. Most cameras support different operation modes. Consult the manual of your camera to obtain the necessary information how to configure the camera to the desired pixel format.

Ensure that the lines transferred by the camera do not exceed the maximum allowed line length for this applet (32768).

With the following parameters you can define the way trigger packets are sent from the frame grabber to the camera on the CXP link.

2.1. PixelFormat

This parameter specifies the data format of the connected camera.

The formats defined in the following list can be selected. Choose the pixel format which best matches with your camera.

In this applet, the processing data bit depth is 16 bit. The camera interface automatically performs a conversion to the 16 bit format using bit shifting independently from the selected camera format. If the camera bit depth is greater than the processing bit depth, bits will be right shifted to meet the internal bit depth. If the camera bit depth is less than the processing bit depth, bits will be left shifted to meet the internal bit depth. In this case, the lower bits are fixed to zero.



GenTL Controls the Pixel Format

The GenTL interface has a built in automatic adaptation of the pixel format to the camera settings. Changing the applet pixel format might be overwritten by the GenTL on acquisition start. You can only set the pixel format if the automatic setting is disabled. See the GenTL documentation parameter **AutomaticFormatControl** for more details.

Table 2.1. Parameter properties of PixelFormat

Property	Value
Name	PixelFormat
Display Name	Pixel Format
Interface	IEnumeration
Access policy	Read/Write/Change
Visibility	Beginner
Allowed values	Mono8 Mono 8 Mono10p Mono 10p Mono12p Mono 12p Mono14p Mono 14p Mono16 Mono 16p RGB8 RGB 8 RGB10p RGB 10p RGB12p RGB 12p RGB14p RGB 14p RGB16 RGB 16 YCbCr422_8 YCbCr422_8
Default value	Mono8

Example 2.1. Usage of PixelFormat

```
/* Set */ PixelFormat = Mono8;
/* Get */ value_ = PixelFormat;
```

2.2. SystemmonitorUsedCxpConnections

The currently used number of CXP ports used in this process.

Table 2.2. Parameter properties of SystemmonitorUsedCxpConnections

Property	Value
Name	SystemmonitorUsedCxpConnections
Display Name	System Monitor Used Cxp Connections
Interface	IInteger
Access policy	Read-Only
Visibility	Beginner
Allowed values	Minimum 1 Maximum 4 Stepsize 1

Example 2.2. Usage of SystemmonitorUsedCxpConnections

```
/* Get */ value_ = SystemmonitorUsedCxpConnections;
```

2.3. PacketTagErrorCount

The parameter reflects the current status of the camera operator. The parameter signalizes CXP stream packet loss detection.

Table 2.3. Parameter properties of PacketTagErrorCount

Property	Value
Name	PacketTagErrorCount
Display Name	Packet Tag Error Count
Interface	IInteger
Access policy	Read-Only
Visibility	Beginner
Allowed values	Minimum 0 Maximum 4095 Stepsize 1

Example 2.3. Usage of PacketTagErrorCount

```
/* Get */ value_ = PacketTagErrorCount;
```

2.4. CorrectedErrorCount

The parameter reflects the current status of the camera operator. The parameter signalizes single byte error correction in CXP stream packets.

Table 2.4. Parameter properties of CorrectedErrorCount

Property	Value
Name	CorrectedErrorCount
Display Name	Corrected Error Count
Interface	IInteger
Access policy	Read-Only
Visibility	Beginner
Allowed values	Minimum 0 Maximum 4095 Stepsize 1

Example 2.4. Usage of CorrectedErrorCount

```
/* Get */ value_ = CorrectedErrorCount;
```

2.5. UncorrectedErrorCount

The parameter reflects the current status of the camera operator. The parameter signals multiple byte error detection in CXP stream packets.

Table 2.5. Parameter properties of UncorrectedErrorCount

Property	Value
Name	UncorrectedErrorCount
Display Name	Uncorrected Error Count
Interface	IInteger
Access policy	Read-Only
Visibility	Beginner
Allowed values	Minimum 0 Maximum 4095 Stepsize 1

Example 2.5. Usage of UncorrectedErrorCount

```
/* Get */ value_ = UncorrectedErrorCount;
```

2.6. SystemmonitorPacketbufferOverflowCount

Represents the number of overflows, if an overflow occurred due to not correctly aligned package order.

Table 2.6. Parameter properties of SystemmonitorPacketbufferOverflowCount

Property	Value
Name	SystemmonitorPacketbufferOverflowCount
Display Name	System Monitor Packet Buffer Overflow Count
Interface	IInteger
Access policy	Read-Only
Visibility	Beginner
Allowed values	Minimum 0 Maximum 4095 Stepsize 1

Example 2.6. Usage of SystemmonitorPacketbufferOverflowCount

```
/* Get */ value_ = SystemmonitorPacketbufferOverflowCount;
```

2.7. SystemmonitorPacketbufferOverflowSource

This parameter represents the port, which has overflows due to not correctly aligned package order.

Table 2.7. Parameter properties of SystemmonitorPacketbufferOverflowSource

Property	Value
Name	SystemmonitorPacketbufferOverflowSource
Display Name	System Monitor Packet Buffer Overflow Source
Interface	IInteger
Access policy	Read-Only
Visibility	Beginner
Allowed values	Minimum 0 Maximum 15 Stepsize 1

Example 2.7. Usage of SystemmonitorPacketbufferOverflowSource

```
/* Get */ value_ = SystemmonitorPacketbufferOverflowSource;
```

2.8. SystemmonitorCxpImageLineMode

This parameter informs on the current transfer mode, used by the camera. The transfer can be an areascan (= 0) or linescan (= 1) image.

Table 2.8. Parameter properties of SystemmonitorCxpImageLineMode

Property	Value
Name	SystemmonitorCxpImageLineMode
Display Name	System Monitor Cxp Image Line Mode
Interface	IInteger
Access policy	Read-Only
Visibility	Beginner
Allowed values	Minimum 0 Maximum 1 Stepsize 1

Example 2.8. Usage of SystemmonitorCxpImageLineMode

```
/* Get */ value_ = SystemmonitorCxpImageLineMode;
```

Chapter 3. Camera

This applet Acq_DualCXP12Line for the imaWorx CXP-12 Quad acquires the sensor data of a line scan camera. When this is performed some sensor dimension depending information can be used to register an event based callback function.

3.1. CameraEvents

In programming or runtime environments, a callback function is a piece of executable code that is passed as an argument, which is expected to call back (execute) exactly that time an event is triggered. This applet can generate some software callback events based on applet-events as explained in the following section. These events are not related to a special camera functionality. Other event sources are described in additional sections of this document.

The Basler Framegrabber SDK enables an application to get these event notifications about certain state changes at the data flow from camera to RAM and the image and trigger processing as well. Please consult the Basler Framegrabber SDK documentation for more details concerning the implementation of this functionality.

3.1.1. FrameTransferStart

3.1.2. FrameTransferEnd

3.1.3. LineTransferStart

This event is generated when the first pixel of camera line arrives at the framegrabber. Keep in mind that a high linerate can cause a critical high interrupt rate which might slow down the overall PC system. Even if the trigger setup will not use this line for a generated frame output this event will occur. This event can only occur if the acquisition is running.

3.1.4. LineTransferEnd

This event is generated when the last pixel of camera line has arrives at the framegrabber. Keep in mind that a high linerate can cause a critical high interrupt rate which might slow down the overall PC system. This event can only occur if the acquisition is running.

Chapter 4. SensorGeometry

Some operations, for example mirroring or tap sorting, require knowledge on the sensor dimension and orientation of the camera. The following parameters supply this kind of information.

4.1. VantagePoint

This parameter defines the vantage point. Use this parameter to mirror the image. Note that when using this parameter for mirroring, the received sensor image is mirrored and not the selected ROI in the frame grabber. Therefore, to mirror the ROI in the frame grabber, ensure to set the correct offsets in the frame grabber.

If a horizontal mirroring is active, the parameter *SensorWidth* limits the maximum width. The parameter dependency will then be $OffsetX + Width \leq SensorWidth$.

If a vertical mirroring is active, the parameter *SensorHeight* limits the maximum height. The parameter dependency will then be $OffsetY + Height \leq SensorHeight$.

Table 4.1. Parameter properties of VantagePoint

Property	Value
Name	VantagePoint
Display Name	Vantage Point
Interface	IEnumeration
Access policy	Read/Write
Visibility	Beginner
Allowed values	TopLeft Top Left TopRight Top Right BottomLeft Bottom Left BottomRight Bottom Right
Default value	TopLeft

Example 4.1. Usage of VantagePoint

```
/* Set */ VantagePoint = TopLeft;  
/* Get */ value_ = VantagePoint;
```

4.2. SensorWidth

To mirror the incoming data correctly, the parameter *SensorWidth* is required. The value of *SensorWidth* is ignored, if *VantagePoint* = **Top-Left** or **Bottom-Left**. If also a vertical mirroring is used, the available DRAM and sensor height limit the maximum sensor width. This is so, because the sensor image needs to fit twice into the DRAM, because double buffering is used.



If No Mirroring Is Active, the Value of *SensorWidth* Is Not Used

If no mirroring is active, the value of the parameter *SensorWidth* is not used. Instead, the sum of *OffsetX* and *Width* is used. This makes the use of the module easier as an extra configuration is avoided, if defaults are used.

Table 4.2. Parameter properties of SensorWidth

Property	Value
Name	SensorWidth
Display Name	Sensor Width
Interface	IInteger
Access policy	Read/Write
Visibility	Beginner
Allowed values	Minimum 48 Maximum 32768 Stepsize 16
Default value	1024
Unit of measure	pixel

Example 4.2. Usage of SensorWidth

```
/* Set */ SensorWidth = 1024;
/* Get */ value_ = SensorWidth;
```

4.3. SensorHeight

For vertical mirroring or tap geometry sorting in vertical direction, the applet needs to be parameterized with the exact height transferred from the camera to the frame grabber. If you have set a region of interest in the camera, the parameter *SensorHeight* needs to be set to the ROI size, otherwise use the sensor height.



If Only One Y-Zone Is Used and No Vertical Mirroring Is Active, the Value of *SensorHeight* Is Not Used

If no vertical mirroring is configured the value of the parameter *SensorHeight* is not used. Instead, the sum of *OffsetY* and *Height* is used. This makes the use of the module easier as an extra configuration is avoided, if defaults are used.

Table 4.3. Parameter properties of SensorHeight

Property	Value
Name	SensorHeight
Display Name	Sensor Height
Interface	IInteger
Access policy	Read/Write
Visibility	Beginner
Allowed values	Minimum 1 Maximum 8388607 Stepsize 1
Default value	1024
Unit of measure	pixel

Example 4.3. Usage of SensorHeight

```
/* Set */ SensorHeight = 1024;
/* Get */ value_ = SensorHeight;
```

Chapter 5. ROI

This module allows the definition of a region of interest (ROI), also called area of interest (AOI). A ROI allows the selection of a smaller subset pixel area from the input image. It is defined by using parameters *OffsetX*, *Width*, *OffsetY* and *Height*. The following figure illustrates the parameters.

Figure 5.1. Region of Interest

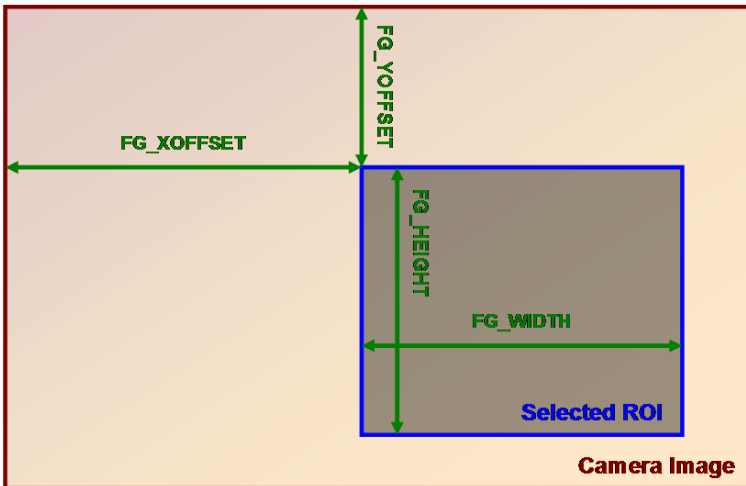

As can be seen, the region of interest lies within the input image dimensions. Thus, if the image dimension provided by the camera is greater or equal to the specified ROI parameters, the applet will fully cut-out the ROI subset pixel area. However, if the image provided by the camera is smaller than the specified ROI, lines will be filled with random pixel content and the image height might be cut or filled with random image lines as illustrated in the following.

Figure 5.2. Region of Interest Selection Outside the Input Image Dimensions

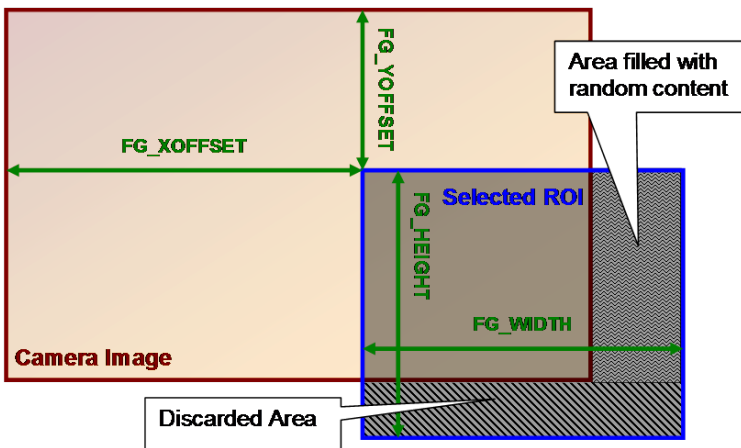

Furthermore, mind that the image sent by the camera must not exceed the maximum allowed image dimensions. This applet allows a maximum image width of 32768 pixels and a maximum image height of 8388607 lines. The chosen ROI settings can have a direct influence on the maximum bandwidth of the applet as they define the image size and thus, define the amount of data.

The parameters have dynamic value ranges. For example an x-offset cannot be set if the sum of the offset and the image width will exceed the maximum image width. To set a high x-offset, the image width has to be reduced, first. Hence, the order of setting the parameters for this module is important. The return values of the function calls in the SDK should always be evaluated to check if changes were accepted.

Mind the minimum step size of the parameters. This applet has a minimum step size of 16 pixel for the width and the x-offset, while the step size for the height and the y-offset is 1.

The settings made in this module will define the display size and buffer size if the applet is used in microDisplay. If you use the applet in your own programs, ensure to define a sufficient buffer size for the DMA transfers in your PC memory.

All ROI parameters can only be changed if the acquisition is not started i.e. stopped.



Automatic Adaptation to Camera Width and Height with the GenTL Adaptor

The GenTL adaptor can automatically copy the image width and height from the camera to the applet settings so that the user does not have to set these values. Changing the *Width* and *Height* of the applet might get overwritten by the Gen TL on acquisition start. You can only set the width and height if this automatic adaptation is disabled. See the GenTL documentation parameter **AutomaticROIControl** for more details.



ROI Setting Defines GenTL Buffer Info

The parameters define the DMA output size and therefore the GenTL buffer info values to inform the consumer about the used output image width and height of the interface. See the GenTL documentation parameter **AutomaticROIControl** for more details.



Influence on Bandwidth

A ROI might cause a strong reduction of the required bandwidth. If possible, the camera frame dimension should be reduced directly in the camera to the desired size instead of reducing the size in the applet. This will reduce the required bandwidth between the camera and the frame grabber.

5.1. Width

The parameter specifies the width of the ROI. The values of parameters *Width* + *OffsetX* must not exceed the maximum image width of 32768 pixels. If a horizontal mirroring is active the sensor width limits the maximum width (*Width* + *XOffset*). If furthermore vertical mirroring is active the maximum width is limited by the DRAM and sensor height (the sensor dimension needs to fit into the DRAM).



Maximum image width is reduced for horizontal mirrored images

Limitations of the available BRAM in the FPGA allow only to store smaller lines and there for the images that can be mirrored needs to be smaller. A mirrored image can only have width of 21840, the not mirrored image can have the full width of 32768.

Table 5.1. Parameter properties of Width

Property	Value
Name	Width
Display Name	Width
Interface	IInteger
Access policy	Read/Write
Visibility	Expert
Allowed values	Minimum 48 Maximum 32768 Stepsize 16
Default value	1024
Unit of measure	pixel

Example 5.1. Usage of Width

```
/* Set */ Width = 1024;
/* Get */ value_ = Width;
```

5.2. Height

The parameter specifies the height of the ROI. The values of parameters *Height* + *OffsetY* must not exceed the maximum image height of 8388607 pixels. If a vertical mirroring is active the sensor height limits the maximum height (*Height* + *YOffset*). Furthermore the maximum height is limited by the DRAM and the sensor width (the sensor dimension needs to fit into the DRAM).

Table 5.2. Parameter properties of Height

Property	Value
Name	Height
Display Name	Height
Interface	IInteger
Access policy	Read/Write
Visibility	Expert
Allowed values	Minimum 1 Maximum 8388607 Stepsize 1
Default value	1024
Unit of measure	pixel

Example 5.2. Usage of Height

```
/* Set */ Height = 1024;
/* Get */ value_ = Height;
```

5.3. OffsetX

The x-offset is defined by this parameter. If a horizontal mirroring is active the sensor width limits the maximum width (*Width* + *XOffset*). If furthermore vertical mirroring is active the maximum width is limited by the DRAM and the sensor height (the sensor dimension needs to fit into the DRAM).

Table 5.3. Parameter properties of OffsetX

Property	Value
Name	OffsetX
Display Name	Offset X
Interface	IInteger
Access policy	Read/Write
Visibility	Expert
Allowed values	Minimum 0 Maximum 32720 Stepsize 16
Default value	0
Unit of measure	pixel

Example 5.3. Usage of OffsetX

```
/* Set */ OffsetX = 0;
/* Get */ value_ = OffsetX;
```

5.4. OffsetY

The y-offset is defined by this parameter. If a vertical mirroring is active the sensor height limits the maximum height (Height + YOffset). Furthermore the maximum height is limited by the DRAM and the sensor width (the sensor dimension needs to fit into the DRAM).

Table 5.4. Parameter properties of OffsetY

Property	Value
Name	OffsetY
Display Name	Offset Y
Interface	IInteger
Access policy	Read/Write
Visibility	Expert
Allowed values	Minimum 0 Maximum 8388606 Stepsize 1
Default value	0
Unit of measure	pixel

Example 5.4. Usage of OffsetY

```
/* Set */ OffsetY = 0;
/* Get */ value_ = OffsetY;
```

Chapter 6. DigitalIO

The frame grabber provides digital inputs and digital outputs for triggering, light synchronization, hardware control etc. This imaWorx CXP-12 Quad frame grabber has

- 8 general purpose digital inputs (GPIs) using the extension board connector of the frame grabber.
- 8 digital outputs on the GPO connector
- trigger over CXP cable function

This AcquisitionApplets allows an arbitrary mapping of the inputs to the trigger processing modules of the frame grabber. The same applies for the outputs: Any signal source from the trigger modules or digital inputs can be selected.

- **GND**: Value set to GND, zero. For digital outputs check for possibly inverted outputs.
- **VCC**: Value set to VCC, one. For digital outputs check for possibly inverted outputs.
- **SignalExsync**: The Exsync signal. Usually the line trigger signal used to trigger the camera. Check Chapter 7, '*LineTriggerExSync*' for more information.
- **SignalExsync2**: The Exsync 2 signal a delayed exsync signal. Check *LineTriggerDelay* for more information.
- **SignalFlash**: The flash signal. It is generated once at the start of each frame generated by the trigger module. Check Chapter 8, '*ImageTriggerFlash*' for more information.
- **SignalLineValid**: The line valid signal of the received camera or simulator image data. The signal is high for the duration of the line data transfer.
- **SignalFrameValid**: The frame valid signal after the trigger module. The signal is high for the duration of the frame data transfer. Depending on the image trigger mode, the image dimension and timing the signal can vary. See Chapter 8, '*ImageTriggerFlash*' for more information.
- Multi camera applet signal sources: The above signal source are available for all camera processes. Thus you can arbitrary select each signal. For example, you can use the same internal exsync signal to trigger all cameras. This allows a 100% synchronization of the cameras.
- **SignalGPIO** to **SignalGPIO7**: Direct mapping of the digital input signal after debouncing.
- **SignalLineStart**: Line start pulse. Use for events and signal analyzer.
- **SignalLineEnd**: Line end pulse. Use for events and signal analyzer.
- **SignalFrameStart**: Frame start pulse. Use for events and signal analyzer.
- **SignalFrameEnd**: Frame end pulse. Use for events and signal analyzer.

6.1. CameraTriggerSource

For CoaXPress triggering, packets are sent to the camera instead of signals. A trigger signal usually consists of a pulse of a certain pulse length defining, for example, the duration time of the exposure. The start of the pulse, i.e. the rising edge, defines the start of the exposure. For most cameras the moment of this rising edge of the pulse is used to send a CXP trigger on CXP LinkTrigger0. At the time of the falling edge, the CXP LinkTrigger1 is used by many cameras to end the exposure in a trigger controlled mode.

Thus, you need to select the source signals for the CXP link triggers and define whether you want to use the rising or falling edge. You can do this with the following parameter. Note that the camera must match with these settings.

6.1.1. CxpLinkTrigger0Source

Table 6.1. Parameter properties of CxpLinkTrigger0Source

Property	Value																																																
Name	CxpLinkTrigger0Source																																																
Display Name	CXP Link Trigger 0 Source																																																
Interface	IEnumeration																																																
Access policy	Read/Write/Change																																																
Visibility	Beginner																																																
Allowed values	<table border="0"> <tr><td>GND</td><td>GND</td></tr> <tr><td>VCC</td><td>VCC</td></tr> <tr><td>SignalExsync</td><td>Signal Exsync</td></tr> <tr><td>SignalExsync2</td><td>Signal Exsync2</td></tr> <tr><td>SignalFlash</td><td>Signal Flash</td></tr> <tr><td>SignalLineValid</td><td>Signal Line Valid</td></tr> <tr><td>SignalFrameValid</td><td>Signal Frame Valid</td></tr> <tr><td>SignalCam1Exsync</td><td>Signal Cam1 Exsync</td></tr> <tr><td>SignalCam1Exsync2</td><td>Signal Cam1 Exsync2</td></tr> <tr><td>SignalCam1Flash</td><td>Signal Cam1 Flash</td></tr> <tr><td>SignalCam1LineValid</td><td>Signal Cam1 Line Valid</td></tr> <tr><td>SignalCam1FrameValid</td><td>Signal Cam1 Frame Valid</td></tr> <tr><td>SignalGPI0</td><td>Signal GPI 0</td></tr> <tr><td>SignalGPI1</td><td>Signal GPI 1</td></tr> <tr><td>SignalGPI2</td><td>Signal GPI 2</td></tr> <tr><td>SignalGPI3</td><td>Signal GPI 3</td></tr> <tr><td>SignalGPI4</td><td>Signal GPI 4</td></tr> <tr><td>SignalGPI5</td><td>Signal GPI 5</td></tr> <tr><td>SignalGPI6</td><td>Signal GPI 6</td></tr> <tr><td>SignalGPI7</td><td>Signal GPI 7</td></tr> <tr><td>SignalFrontGPI0</td><td>Signal Front GPI 0</td></tr> <tr><td>SignalFrontGPI1</td><td>Signal Front GPI 1</td></tr> <tr><td>SignalFrontGPI2</td><td>Signal Front GPI 2</td></tr> <tr><td>SignalFrontGPI3</td><td>Signal Front GPI 3</td></tr> </table>	GND	GND	VCC	VCC	SignalExsync	Signal Exsync	SignalExsync2	Signal Exsync2	SignalFlash	Signal Flash	SignalLineValid	Signal Line Valid	SignalFrameValid	Signal Frame Valid	SignalCam1Exsync	Signal Cam1 Exsync	SignalCam1Exsync2	Signal Cam1 Exsync2	SignalCam1Flash	Signal Cam1 Flash	SignalCam1LineValid	Signal Cam1 Line Valid	SignalCam1FrameValid	Signal Cam1 Frame Valid	SignalGPI0	Signal GPI 0	SignalGPI1	Signal GPI 1	SignalGPI2	Signal GPI 2	SignalGPI3	Signal GPI 3	SignalGPI4	Signal GPI 4	SignalGPI5	Signal GPI 5	SignalGPI6	Signal GPI 6	SignalGPI7	Signal GPI 7	SignalFrontGPI0	Signal Front GPI 0	SignalFrontGPI1	Signal Front GPI 1	SignalFrontGPI2	Signal Front GPI 2	SignalFrontGPI3	Signal Front GPI 3
GND	GND																																																
VCC	VCC																																																
SignalExsync	Signal Exsync																																																
SignalExsync2	Signal Exsync2																																																
SignalFlash	Signal Flash																																																
SignalLineValid	Signal Line Valid																																																
SignalFrameValid	Signal Frame Valid																																																
SignalCam1Exsync	Signal Cam1 Exsync																																																
SignalCam1Exsync2	Signal Cam1 Exsync2																																																
SignalCam1Flash	Signal Cam1 Flash																																																
SignalCam1LineValid	Signal Cam1 Line Valid																																																
SignalCam1FrameValid	Signal Cam1 Frame Valid																																																
SignalGPI0	Signal GPI 0																																																
SignalGPI1	Signal GPI 1																																																
SignalGPI2	Signal GPI 2																																																
SignalGPI3	Signal GPI 3																																																
SignalGPI4	Signal GPI 4																																																
SignalGPI5	Signal GPI 5																																																
SignalGPI6	Signal GPI 6																																																
SignalGPI7	Signal GPI 7																																																
SignalFrontGPI0	Signal Front GPI 0																																																
SignalFrontGPI1	Signal Front GPI 1																																																
SignalFrontGPI2	Signal Front GPI 2																																																
SignalFrontGPI3	Signal Front GPI 3																																																
Default value	SignalExsync																																																

Example 6.1. Usage of CxpLinkTrigger0Source

```
/* Set */ CxpLinkTrigger0Source = SignalExsync;
/* Get */ value_ = CxpLinkTrigger0Source;
```

6.1.2. CxpLinkTrigger0SourceEdge

Table 6.2. Parameter properties of CxpLinkTrigger0SourceEdge

Property	Value				
Name	CxpLinkTrigger0SourceEdge				
Display Name	CXP Link Trigger 0 Source Edge				
Interface	IEnumeration				
Access policy	Read/Write/Change				
Visibility	Beginner				
Allowed values	<table border="0"> <tr><td>RisingEdge</td><td>Rising Edge</td></tr> <tr><td>FallingEdge</td><td>Falling Edge</td></tr> </table>	RisingEdge	Rising Edge	FallingEdge	Falling Edge
RisingEdge	Rising Edge				
FallingEdge	Falling Edge				
Default value	RisingEdge				

Example 6.2. Usage of CxpLinkTrigger0SourceEdge

```
/* Set */ CxpLinkTrigger0SourceEdge = RisingEdge;
/* Get */ value_ = CxpLinkTrigger0SourceEdge;
```

6.1.3. CxpLinkTrigger1Source

Table 6.3. Parameter properties of CxpLinkTrigger1Source

Property	Value
Name	CxpLinkTrigger1Source
Display Name	CXP Link Trigger 1 Source
Interface	IEnumeration
Access policy	Read/Write/Change
Visibility	Beginner
Allowed values	GND VCC SignalExsync SignalExsync2 SignalFlash SignalLineValid SignalFrameValid SignalCam1Exsync SignalCam1Exsync2 SignalCam1Flash SignalCam1LineValid SignalCam1FrameValid SignalGPI0 SignalGPI1 SignalGPI2 SignalGPI3 SignalGPI4 SignalGPI5 SignalGPI6 SignalGPI7 SignalFrontGPI0 SignalFrontGPI1 SignalFrontGPI2 SignalFrontGPI3
Default value	SignalExsync

Example 6.3. Usage of CxpLinkTrigger1Source

```
/* Set */ CxpLinkTrigger1Source = SignalExsync;
/* Get */ value_ = CxpLinkTrigger1Source;
```

6.1.4. CxpLinkTrigger1SourceEdge

Table 6.4. Parameter properties of CxpLinkTrigger1SourceEdge

Property	Value
Name	CxpLinkTrigger1SourceEdge
Display Name	CXP Link Trigger 1 Source Edge
Interface	IEnumeration
Access policy	Read/Write/Change
Visibility	Beginner
Allowed values	RisingEdge Rising Edge FallingEdge Falling Edge
Default value	FallingEdge

Example 6.4. Usage of CxpLinkTrigger1SourceEdge

```
/* Set */ CxpLinkTrigger1SourceEdge = FallingEdge;
/* Get */ value_ = CxpLinkTrigger1SourceEdge;
```

6.1.5. CxpLinkTrigger2Source

Table 6.5. Parameter properties of CxpLinkTrigger2Source

Property	Value
Name	CxpLinkTrigger2Source
Display Name	CXP Link Trigger 2 Source
Interface	IEnumeration
Access policy	Read/Write/Change
Visibility	Beginner
Allowed values	GND GND VCC VCC SignalExsync Signal Exsync SignalExsync2 Signal Exsync2 SignalFlash Signal Flash SignalLineValid Signal Line Valid SignalFrameValid Signal Frame Valid SignalCam1Exsync Signal Cam1 Exsync SignalCam1Exsync2 Signal Cam1 Exsync2 SignalCam1Flash Signal Cam1 Flash SignalCam1LineValid Signal Cam1 Line Valid SignalCam1FrameValid Signal Cam1 Frame Valid SignalGPI0 Signal GPI 0 SignalGPI1 Signal GPI 1 SignalGPI2 Signal GPI 2 SignalGPI3 Signal GPI 3 SignalGPI4 Signal GPI 4 SignalGPI5 Signal GPI 5 SignalGPI6 Signal GPI 6 SignalGPI7 Signal GPI 7 SignalFrontGPI0 Signal Front GPI 0 SignalFrontGPI1 Signal Front GPI 1 SignalFrontGPI2 Signal Front GPI 2 SignalFrontGPI3 Signal Front GPI 3
Default value	GND

Example 6.5. Usage of CxpLinkTrigger2Source

```
/* Set */ CxpLinkTrigger2Source = GND;
/* Get */ value_ = CxpLinkTrigger2Source;
```

6.1.6. CxpLinkTrigger2SourceEdge

Table 6.6. Parameter properties of CxpLinkTrigger2SourceEdge

Property	Value
Name	CxpLinkTrigger2SourceEdge
Display Name	CXP Link Trigger 2 Source Edge
Interface	IEnumeration
Access policy	Read/Write/Change
Visibility	Beginner
Allowed values	RisingEdge Rising Edge FallingEdge Falling Edge
Default value	RisingEdge

Example 6.6. Usage of CxpLinkTrigger2SourceEdge

```
/* Set */ CxpLinkTrigger2SourceEdge = RisingEdge;
/* Get */ value_ = CxpLinkTrigger2SourceEdge;
```

6.1.7. CxpLinkTrigger3Source

Table 6.7. Parameter properties of CxpLinkTrigger3Source

Property	Value
Name	CxpLinkTrigger3Source
Display Name	CXP Link Trigger 3 Source
Interface	IEnumeration
Access policy	Read/Write/Change
Visibility	Beginner
Allowed values	GND GND VCC VCC SignalExsync Signal Exsync SignalExsync2 Signal Exsync2 SignalFlash Signal Flash SignalLineValid Signal Line Valid SignalFrameValid Signal Frame Valid SignalCam1Exsync Signal Cam1 Exsync SignalCam1Exsync2 Signal Cam1 Exsync2 SignalCam1Flash Signal Cam1 Flash SignalCam1LineValid Signal Cam1 Line Valid SignalCam1FrameValid Signal Cam1 Frame Valid SignalGPI0 Signal GPI 0 SignalGPI1 Signal GPI 1 SignalGPI2 Signal GPI 2 SignalGPI3 Signal GPI 3 SignalGPI4 Signal GPI 4 SignalGPI5 Signal GPI 5 SignalGPI6 Signal GPI 6 SignalGPI7 Signal GPI 7 SignalFrontGPI0 Signal Front GPI 0 SignalFrontGPI1 Signal Front GPI 1 SignalFrontGPI2 Signal Front GPI 2 SignalFrontGPI3 Signal Front GPI 3
Default value	GND

Example 6.7. Usage of CxpLinkTrigger3Source

```
/* Set */ CxpLinkTrigger3Source = GND;
/* Get */ value_ = CxpLinkTrigger3Source;
```

6.1.8. CxpLinkTrigger3SourceEdge

Table 6.8. Parameter properties of CxpLinkTrigger3SourceEdge

Property	Value
Name	CxpLinkTrigger3SourceEdge
Display Name	CXP Link Trigger 3 Source Edge
Interface	IEnumeration
Access policy	Read/Write/Change
Visibility	Beginner
Allowed values	RisingEdge Rising Edge FallingEdge Falling Edge
Default value	RisingEdge

Example 6.8. Usage of CxpLinkTrigger3SourceEdge

```
/* Set */ CxpLinkTrigger3SourceEdge = RisingEdge;
/* Get */ value_ = CxpLinkTrigger3SourceEdge;
```

6.2. GPO

6.2.1. TriggerOutGPO0Source et al.



Note

This description applies also to the following parameters: `TriggerOutGPO1Source`, `TriggerOutGPO2Source`, `TriggerOutGPO3Source`, `TriggerOutGPO4Source`, `TriggerOutGPO5Source`, `TriggerOutGPO6Source`, `TriggerOutGPO7Source`

Select the signal source of the General Purpose Output (GPO). For further explanation of the available sources see Chapter 6, 'DigitalIO'.

You can change the polarity using parameter `TriggerOutGPO0Polarity`.

Table 6.9. Parameter properties of `TriggerOutGPO0Source`

Property	Value																																																
Name	<code>TriggerOutGPO0Source</code>																																																
Display Name	Trigger Out GPO 0 Source																																																
Interface	<code>IEnumeration</code>																																																
Access policy	Read/Write/Change																																																
Visibility	Beginner																																																
Allowed values	<table border="0"> <tr><td><code>GND</code></td><td>GND</td></tr> <tr><td><code>VCC</code></td><td>VCC</td></tr> <tr><td><code>SignalExsync</code></td><td>Signal Exsync</td></tr> <tr><td><code>SignalExsync2</code></td><td>Signal Exsync2</td></tr> <tr><td><code>SignalFlash</code></td><td>Signal Flash</td></tr> <tr><td><code>SignalLineValid</code></td><td>Signal Line Valid</td></tr> <tr><td><code>SignalFrameValid</code></td><td>Signal Frame Valid</td></tr> <tr><td><code>SignalCam1Exsync</code></td><td>Signal Cam1 Exsync</td></tr> <tr><td><code>SignalCam1Exsync2</code></td><td>Signal Cam1 Exsync2</td></tr> <tr><td><code>SignalCam1Flash</code></td><td>Signal Cam1 Flash</td></tr> <tr><td><code>SignalCam1LineValid</code></td><td>Signal Cam1 Line Valid</td></tr> <tr><td><code>SignalCam1FrameValid</code></td><td>Signal Cam1 Frame Valid</td></tr> <tr><td><code>SignalGPI0</code></td><td>Signal GPI 0</td></tr> <tr><td><code>SignalGPI1</code></td><td>Signal GPI 1</td></tr> <tr><td><code>SignalGPI2</code></td><td>Signal GPI 2</td></tr> <tr><td><code>SignalGPI3</code></td><td>Signal GPI 3</td></tr> <tr><td><code>SignalGPI4</code></td><td>Signal GPI 4</td></tr> <tr><td><code>SignalGPI5</code></td><td>Signal GPI 5</td></tr> <tr><td><code>SignalGPI6</code></td><td>Signal GPI 6</td></tr> <tr><td><code>SignalGPI7</code></td><td>Signal GPI 7</td></tr> <tr><td><code>SignalFrontGPI0</code></td><td>Signal Front GPI 0</td></tr> <tr><td><code>SignalFrontGPI1</code></td><td>Signal Front GPI 1</td></tr> <tr><td><code>SignalFrontGPI2</code></td><td>Signal Front GPI 2</td></tr> <tr><td><code>SignalFrontGPI3</code></td><td>Signal Front GPI 3</td></tr> </table>	<code>GND</code>	GND	<code>VCC</code>	VCC	<code>SignalExsync</code>	Signal Exsync	<code>SignalExsync2</code>	Signal Exsync2	<code>SignalFlash</code>	Signal Flash	<code>SignalLineValid</code>	Signal Line Valid	<code>SignalFrameValid</code>	Signal Frame Valid	<code>SignalCam1Exsync</code>	Signal Cam1 Exsync	<code>SignalCam1Exsync2</code>	Signal Cam1 Exsync2	<code>SignalCam1Flash</code>	Signal Cam1 Flash	<code>SignalCam1LineValid</code>	Signal Cam1 Line Valid	<code>SignalCam1FrameValid</code>	Signal Cam1 Frame Valid	<code>SignalGPI0</code>	Signal GPI 0	<code>SignalGPI1</code>	Signal GPI 1	<code>SignalGPI2</code>	Signal GPI 2	<code>SignalGPI3</code>	Signal GPI 3	<code>SignalGPI4</code>	Signal GPI 4	<code>SignalGPI5</code>	Signal GPI 5	<code>SignalGPI6</code>	Signal GPI 6	<code>SignalGPI7</code>	Signal GPI 7	<code>SignalFrontGPI0</code>	Signal Front GPI 0	<code>SignalFrontGPI1</code>	Signal Front GPI 1	<code>SignalFrontGPI2</code>	Signal Front GPI 2	<code>SignalFrontGPI3</code>	Signal Front GPI 3
<code>GND</code>	GND																																																
<code>VCC</code>	VCC																																																
<code>SignalExsync</code>	Signal Exsync																																																
<code>SignalExsync2</code>	Signal Exsync2																																																
<code>SignalFlash</code>	Signal Flash																																																
<code>SignalLineValid</code>	Signal Line Valid																																																
<code>SignalFrameValid</code>	Signal Frame Valid																																																
<code>SignalCam1Exsync</code>	Signal Cam1 Exsync																																																
<code>SignalCam1Exsync2</code>	Signal Cam1 Exsync2																																																
<code>SignalCam1Flash</code>	Signal Cam1 Flash																																																
<code>SignalCam1LineValid</code>	Signal Cam1 Line Valid																																																
<code>SignalCam1FrameValid</code>	Signal Cam1 Frame Valid																																																
<code>SignalGPI0</code>	Signal GPI 0																																																
<code>SignalGPI1</code>	Signal GPI 1																																																
<code>SignalGPI2</code>	Signal GPI 2																																																
<code>SignalGPI3</code>	Signal GPI 3																																																
<code>SignalGPI4</code>	Signal GPI 4																																																
<code>SignalGPI5</code>	Signal GPI 5																																																
<code>SignalGPI6</code>	Signal GPI 6																																																
<code>SignalGPI7</code>	Signal GPI 7																																																
<code>SignalFrontGPI0</code>	Signal Front GPI 0																																																
<code>SignalFrontGPI1</code>	Signal Front GPI 1																																																
<code>SignalFrontGPI2</code>	Signal Front GPI 2																																																
<code>SignalFrontGPI3</code>	Signal Front GPI 3																																																
Default value	<code>SignalFlash</code>																																																

Example 6.9. Usage of TriggerOutGPO0Source

```
/* Set */ TriggerOutGPO0Source = SignalFlash;
/* Get */ value_ = TriggerOutGPO0Source;
```

6.2.2. TriggerOutGPO0Polarity et al.**Note**

This description applies also to the following parameters: TriggerOutGPO1Polarity, TriggerOutGPO2Polarity, TriggerOutGPO3Polarity, TriggerOutGPO4Polarity, TriggerOutGPO5Polarity, TriggerOutGPO6Polarity, TriggerOutGPO7Polarity

Select the output polarity the General Purpose Output (GPO). For further explanation of the available sources see Chapter 6, 'DigitalIO'.

Table 6.10. Parameter properties of TriggerOutGPO0Polarity

Property	Value
Name	TriggerOutGPO0Polarity
Display Name	Trigger Out GPO 0 Polarity
Interface	IEnumeration
Access policy	Read/Write/Change
Visibility	Beginner
Allowed values	LowActive Low Active HighActive High Active
Default value	HighActive

Example 6.10. Usage of TriggerOutGPO0Polarity

```
/* Set */ TriggerOutGPO0Polarity = HighActive;
/* Get */ value_ = TriggerOutGPO0Polarity;
```

6.2.3. TriggerOutFrontGPO0Source et al.**Note**

This description applies also to the following parameters: TriggerOutFrontGPO1Source

Select the signal source of the Front General Purpose Output (Front GPO). For further explanation of the available sources see Chapter 6, 'DigitalIO'.

You can change the polarity using parameter *TriggerFrontOutGPO0Polarity*.

Table 6.11. Parameter properties of TriggerOutFrontGPO0Source

Property	Value																																																
Name	TriggerOutFrontGPO0Source																																																
Display Name	Trigger Out Front GPO 0 Source																																																
Interface	IEnumeration																																																
Access policy	Read/Write/Change																																																
Visibility	Beginner																																																
Allowed values	<table border="0"> <tr><td>GND</td><td>GND</td></tr> <tr><td>VCC</td><td>VCC</td></tr> <tr><td>SignalExsync</td><td>Signal Exsync</td></tr> <tr><td>SignalExsync2</td><td>Signal Exsync2</td></tr> <tr><td>SignalFlash</td><td>Signal Flash</td></tr> <tr><td>SignalLineValid</td><td>Signal Line Valid</td></tr> <tr><td>SignalFrameValid</td><td>Signal Frame Valid</td></tr> <tr><td>SignalCam1Exsync</td><td>Signal Cam1 Exsync</td></tr> <tr><td>SignalCam1Exsync2</td><td>Signal Cam1 Exsync2</td></tr> <tr><td>SignalCam1Flash</td><td>Signal Cam1 Flash</td></tr> <tr><td>SignalCam1LineValid</td><td>Signal Cam1 Line Valid</td></tr> <tr><td>SignalCam1FrameValid</td><td>Signal Cam1 Frame Valid</td></tr> <tr><td>SignalGPI0</td><td>Signal GPI 0</td></tr> <tr><td>SignalGPI1</td><td>Signal GPI 1</td></tr> <tr><td>SignalGPI2</td><td>Signal GPI 2</td></tr> <tr><td>SignalGPI3</td><td>Signal GPI 3</td></tr> <tr><td>SignalGPI4</td><td>Signal GPI 4</td></tr> <tr><td>SignalGPI5</td><td>Signal GPI 5</td></tr> <tr><td>SignalGPI6</td><td>Signal GPI 6</td></tr> <tr><td>SignalGPI7</td><td>Signal GPI 7</td></tr> <tr><td>SignalFrontGPI0</td><td>Signal Front GPI 0</td></tr> <tr><td>SignalFrontGPI1</td><td>Signal Front GPI 1</td></tr> <tr><td>SignalFrontGPI2</td><td>Signal Front GPI 2</td></tr> <tr><td>SignalFrontGPI3</td><td>Signal Front GPI 3</td></tr> </table>	GND	GND	VCC	VCC	SignalExsync	Signal Exsync	SignalExsync2	Signal Exsync2	SignalFlash	Signal Flash	SignalLineValid	Signal Line Valid	SignalFrameValid	Signal Frame Valid	SignalCam1Exsync	Signal Cam1 Exsync	SignalCam1Exsync2	Signal Cam1 Exsync2	SignalCam1Flash	Signal Cam1 Flash	SignalCam1LineValid	Signal Cam1 Line Valid	SignalCam1FrameValid	Signal Cam1 Frame Valid	SignalGPI0	Signal GPI 0	SignalGPI1	Signal GPI 1	SignalGPI2	Signal GPI 2	SignalGPI3	Signal GPI 3	SignalGPI4	Signal GPI 4	SignalGPI5	Signal GPI 5	SignalGPI6	Signal GPI 6	SignalGPI7	Signal GPI 7	SignalFrontGPI0	Signal Front GPI 0	SignalFrontGPI1	Signal Front GPI 1	SignalFrontGPI2	Signal Front GPI 2	SignalFrontGPI3	Signal Front GPI 3
GND	GND																																																
VCC	VCC																																																
SignalExsync	Signal Exsync																																																
SignalExsync2	Signal Exsync2																																																
SignalFlash	Signal Flash																																																
SignalLineValid	Signal Line Valid																																																
SignalFrameValid	Signal Frame Valid																																																
SignalCam1Exsync	Signal Cam1 Exsync																																																
SignalCam1Exsync2	Signal Cam1 Exsync2																																																
SignalCam1Flash	Signal Cam1 Flash																																																
SignalCam1LineValid	Signal Cam1 Line Valid																																																
SignalCam1FrameValid	Signal Cam1 Frame Valid																																																
SignalGPI0	Signal GPI 0																																																
SignalGPI1	Signal GPI 1																																																
SignalGPI2	Signal GPI 2																																																
SignalGPI3	Signal GPI 3																																																
SignalGPI4	Signal GPI 4																																																
SignalGPI5	Signal GPI 5																																																
SignalGPI6	Signal GPI 6																																																
SignalGPI7	Signal GPI 7																																																
SignalFrontGPI0	Signal Front GPI 0																																																
SignalFrontGPI1	Signal Front GPI 1																																																
SignalFrontGPI2	Signal Front GPI 2																																																
SignalFrontGPI3	Signal Front GPI 3																																																
Default value	SignalFlash																																																

Example 6.11. Usage of TriggerOutFrontGPO0Source

```
/* Set */ TriggerOutFrontGPO0Source = SignalFlash;
/* Get */ value_ = TriggerOutFrontGPO0Source;
```

6.2.4. TriggerFrontOutGPO0Polarity et al.



Note

This description applies also to the following parameters: TriggerFrontOutGPO1Polarity

Select the output polarity the Front General Purpose Output (Front GPO). For further explanation of the available sources see Chapter 6, 'DigitalIO'.

Table 6.12. Parameter properties of TriggerFrontOutGPO0Polarity

Property	Value
Name	TriggerFrontOutGPO0Polarity
Display Name	Trigger Front Out GPO 0 Polarity
Interface	IEnumeration
Access policy	Read/Write/Change
Visibility	Beginner
Allowed values	LowActive Low Active HighActive High Active
Default value	HighActive

Example 6.12. Usage of TriggerFrontOutGPO0Polarity

```
/* Set */ TriggerFrontOutGPO0Polarity = HighActive;
/* Get */ value_ = TriggerFrontOutGPO0Polarity;
```

6.3. GPIState

6.3.1. DigitalInput

Parameter *DigitalInput* is used to monitor the digital inputs of the frame grabber. This AcquisitionApplets has 12 digital inputs. You can read the current state of these inputs using parameter *DigitalInput*. Bit 0 of the read value represents input 0, bit 1 represents input 1 and so on. For example, if you obtain the value 37 or hexadecimal 0x25 the frame grabber will have high level on it's digital inputs 0, 2 and 5.

Table 6.13. Parameter properties of DigitalInput

Property	Value
Name	DigitalInput
Display Name	Digital Input
Interface	IInteger
Access policy	Read-Only
Visibility	Beginner
Allowed values	Minimum 0 Maximum 4095 Stepsize 1
Unit of measure	

Example 6.13. Usage of DigitalInput

```
/* Get */ value_ = DigitalInput;
```

6.4. EventSource

6.4.1. CustomSignalEvent0Source

Select the source for the custom signal event.

Table 6.14. Parameter properties of CustomSignalEvent0Source

Property	Value																																																																
Name	CustomSignalEvent0Source																																																																
Display Name	Custom Signal Event 0 Source																																																																
Interface	IEnumeration																																																																
Access policy	Read/Write/Change																																																																
Visibility	Beginner																																																																
Allowed values	<table border="0"> <tr><td>GND</td><td>GND</td></tr> <tr><td>VCC</td><td>VCC</td></tr> <tr><td>SignalExsync</td><td>Signal Exsync</td></tr> <tr><td>SignalExsync2</td><td>Signal Exsync2</td></tr> <tr><td>SignalFlash</td><td>Signal Flash</td></tr> <tr><td>SignalLineValid</td><td>Signal Line Valid</td></tr> <tr><td>SignalFrameValid</td><td>Signal Frame Valid</td></tr> <tr><td>SignalLineStart</td><td>Signal Line Start</td></tr> <tr><td>SignalLineEnd</td><td>Cam0 Line Transfer End</td></tr> <tr><td>SignalFrameStart</td><td>Signal Frame Start</td></tr> <tr><td>SignalFrameEnd</td><td>Signal Frame End</td></tr> <tr><td>SignalCam1Exsync</td><td>Signal Cam1 Exsync</td></tr> <tr><td>SignalCam1Exsync2</td><td>Signal Cam1 Exsync2</td></tr> <tr><td>SignalCam1Flash</td><td>Signal Cam1 Flash</td></tr> <tr><td>SignalCam1LineValid</td><td>Signal Cam1 Line Valid</td></tr> <tr><td>SignalCam1FrameValid</td><td>Signal Cam1 Frame Valid</td></tr> <tr><td>SignalCam1LineStart</td><td>Signal Cam1 Line Start</td></tr> <tr><td>SignalCam1LineEnd</td><td>Signal Cam1 Line End</td></tr> <tr><td>SignalCam1FrameStart</td><td>Signal Cam1 Frame Start</td></tr> <tr><td>SignalCam1FrameEnd</td><td>Signal Cam1 Frame End</td></tr> <tr><td>SignalGPI0</td><td>Signal GPI 0</td></tr> <tr><td>SignalGPI1</td><td>Signal GPI 1</td></tr> <tr><td>SignalGPI2</td><td>Signal GPI 2</td></tr> <tr><td>SignalGPI3</td><td>Signal GPI 3</td></tr> <tr><td>SignalGPI4</td><td>Signal GPI 4</td></tr> <tr><td>SignalGPI5</td><td>Signal GPI 5</td></tr> <tr><td>SignalGPI6</td><td>Signal GPI 6</td></tr> <tr><td>SignalGPI7</td><td>Signal GPI 7</td></tr> <tr><td>SignalFrontGPI0</td><td>Signal Front GPI 0</td></tr> <tr><td>SignalFrontGPI1</td><td>Signal Front GPI 1</td></tr> <tr><td>SignalFrontGPI2</td><td>Signal Front GPI 2</td></tr> <tr><td>SignalFrontGPI3</td><td>Signal Front GPI 3</td></tr> </table>	GND	GND	VCC	VCC	SignalExsync	Signal Exsync	SignalExsync2	Signal Exsync2	SignalFlash	Signal Flash	SignalLineValid	Signal Line Valid	SignalFrameValid	Signal Frame Valid	SignalLineStart	Signal Line Start	SignalLineEnd	Cam0 Line Transfer End	SignalFrameStart	Signal Frame Start	SignalFrameEnd	Signal Frame End	SignalCam1Exsync	Signal Cam1 Exsync	SignalCam1Exsync2	Signal Cam1 Exsync2	SignalCam1Flash	Signal Cam1 Flash	SignalCam1LineValid	Signal Cam1 Line Valid	SignalCam1FrameValid	Signal Cam1 Frame Valid	SignalCam1LineStart	Signal Cam1 Line Start	SignalCam1LineEnd	Signal Cam1 Line End	SignalCam1FrameStart	Signal Cam1 Frame Start	SignalCam1FrameEnd	Signal Cam1 Frame End	SignalGPI0	Signal GPI 0	SignalGPI1	Signal GPI 1	SignalGPI2	Signal GPI 2	SignalGPI3	Signal GPI 3	SignalGPI4	Signal GPI 4	SignalGPI5	Signal GPI 5	SignalGPI6	Signal GPI 6	SignalGPI7	Signal GPI 7	SignalFrontGPI0	Signal Front GPI 0	SignalFrontGPI1	Signal Front GPI 1	SignalFrontGPI2	Signal Front GPI 2	SignalFrontGPI3	Signal Front GPI 3
GND	GND																																																																
VCC	VCC																																																																
SignalExsync	Signal Exsync																																																																
SignalExsync2	Signal Exsync2																																																																
SignalFlash	Signal Flash																																																																
SignalLineValid	Signal Line Valid																																																																
SignalFrameValid	Signal Frame Valid																																																																
SignalLineStart	Signal Line Start																																																																
SignalLineEnd	Cam0 Line Transfer End																																																																
SignalFrameStart	Signal Frame Start																																																																
SignalFrameEnd	Signal Frame End																																																																
SignalCam1Exsync	Signal Cam1 Exsync																																																																
SignalCam1Exsync2	Signal Cam1 Exsync2																																																																
SignalCam1Flash	Signal Cam1 Flash																																																																
SignalCam1LineValid	Signal Cam1 Line Valid																																																																
SignalCam1FrameValid	Signal Cam1 Frame Valid																																																																
SignalCam1LineStart	Signal Cam1 Line Start																																																																
SignalCam1LineEnd	Signal Cam1 Line End																																																																
SignalCam1FrameStart	Signal Cam1 Frame Start																																																																
SignalCam1FrameEnd	Signal Cam1 Frame End																																																																
SignalGPI0	Signal GPI 0																																																																
SignalGPI1	Signal GPI 1																																																																
SignalGPI2	Signal GPI 2																																																																
SignalGPI3	Signal GPI 3																																																																
SignalGPI4	Signal GPI 4																																																																
SignalGPI5	Signal GPI 5																																																																
SignalGPI6	Signal GPI 6																																																																
SignalGPI7	Signal GPI 7																																																																
SignalFrontGPI0	Signal Front GPI 0																																																																
SignalFrontGPI1	Signal Front GPI 1																																																																
SignalFrontGPI2	Signal Front GPI 2																																																																
SignalFrontGPI3	Signal Front GPI 3																																																																
Default value	SignalExsync																																																																

Example 6.14. Usage of CustomSignalEvent0Source

```
/* Set */ CustomSignalEvent0Source = SignalExsync;
/* Get */ value_ = CustomSignalEvent0Source;
```

6.4.2. CustomSignalEvent0Polarity

Select the polarity for the custom signal event.

Table 6.15. Parameter properties of CustomSignalEvent0Polarity

Property	Value
Name	CustomSignalEvent0Polarity
Display Name	Custom Signal Event 0 Polarity
Interface	IEnumeration
Access policy	Read/Write/Change
Visibility	Beginner
Allowed values	LowActive Low Active HighActive High Active
Default value	HighActive

Example 6.15. Usage of CustomSignalEvent0Polarity

```
/* Set */ CustomSignalEvent0Polarity = HighActive;
/* Get */ value_ = CustomSignalEvent0Polarity;
```

6.4.3. CustomSignalEvent1Source

Select the source for the custom signal event.

Table 6.16. Parameter properties of CustomSignalEvent1Source

Property	Value
Name	CustomSignalEvent1Source
Display Name	Custom Signal Event 1 Source
Interface	IEnumeration
Access policy	Read/Write/Change
Visibility	Beginner
Allowed values	GND VCC SignalExsync SignalExsync2 SignalFlash SignalLineValid SignalFrameValid SignalLineStart SignalLineEnd SignalFrameStart SignalFrameEnd SignalCam1Exsync SignalCam1Exsync2 SignalCam1Flash SignalCam1LineValid SignalCam1FrameValid SignalCam1LineStart SignalCam1LineEnd SignalCam1FrameStart SignalCam1FrameEnd SignalGPI0 SignalGPI1 SignalGPI2 SignalGPI3 SignalGPI4 SignalGPI5 SignalGPI6 SignalGPI7 SignalFrontGPI0 SignalFrontGPI1 SignalFrontGPI2 SignalFrontGPI3
Default value	SignalFlash

Example 6.16. Usage of CustomSignalEvent1Source

```

/* Set */ CustomSignalEvent1Source = SignalFlash;
/* Get */ value_ = CustomSignalEvent1Source;

```

6.4.4. CustomSignalEvent1Polarity

Select the polarity for the custom signal event.

Table 6.17. Parameter properties of CustomSignalEvent1Polarity

Property	Value
Name	CustomSignalEvent1Polarity
Display Name	Custom Signal Event 1 Polarity
Interface	IEnumeration
Access policy	Read/Write/Change
Visibility	Beginner
Allowed values	LowActive Low Active HighActive High Active
Default value	HighActive

Example 6.17. Usage of CustomSignalEvent1Polarity

```
/* Set */ CustomSignalEvent1Polarity = HighActive;
/* Get */ value_ = CustomSignalEvent1Polarity;
```

6.5. Events

In programming or runtime environments, a callback function is a piece of executable code that is passed as an argument, which is expected to call back (execute) exactly that time an event is triggered. This applet can generate some software callback events based on trigger inputs as explained in the following section. These events are not related to a special camera functionality. Other event sources are described in additional sections of this document.

Basler Framegrabber SDK enables an application to get these event notifications about certain state changes at the data flow from camera to RAM and the image and trigger processing as well. Please consult the Basler Framegrabber SDK documentation for more details concerning the implementation of this functionality.

6.5.1. Line0RisingEdge

This event is generated for each rising signal edge at trigger input 0. Except for the timestamp, the event has no additional data included. Keep in mind that fast changes of the input signal can cause high interrupt rates which might slow down the system. This event can occur independent of the acquisition status.

6.5.2. Line0FallingEdge

This event is generated for each falling signal edge at trigger input 0. Except for the timestamp, the event has no additional data included. Keep in mind that fast changes of the input signal can cause high interrupt rates which might slow down the system. This event can occur independent of the acquisition status.

6.5.3. CustomSignalEvent0

The event defined by *CustomSignalEvent0Source* and *CustomSignalEvent0Polarity*.

6.5.4. CustomSignalEvent1

The event defined by *CustomSignalEvent1Source* and *CustomSignalEvent1Polarity*.

Chapter 7. LineTriggerExSync

The line trigger function block uses signals to control the line scan acquisition of the specific camera. A external synchronization signal or internal generated puls with fixed frequency being sent to the line scan camera is called ExSync. With the help of this signal it is possible to control the exposure of the connected camera.

The camera needs to be configured accordingly to use the ExSync as control signal. Furthermore the camera might expect the ExSync at a particular CC signal and/or polarity.

For CoaXPress the the exposure control is sent in two independent packets. A single start- and a single end-packet. The time in between is interpreted as pulse width. The timing of these is very precise.

An sensor exposure control based on pulse length/duration is very common. Please make sure that the exposure time is less than the period of the expected maximum line frequency. Consult the camera's manual for more details because these are device specific. More details concerning ExSync can be found in the parameter description of *ExSyncOn*.

Basically two different generation modes for the ExSync signals are available,

- a simple periodical and
- an externally triggered generation.

Additionally, two variants of these are available,

- the first is independent from the image gate,
- and the second is gated by the image gate, which creates ExSync signals only during the actual acquisition.

All details can be found in the parameter description of *LineTriggerMode*.

For the mapping of the ExSync signals to the digital outputs check Chapter 6, '*DigitalIO*'.

7.1. LineTriggerMode

Please choose one of the line trigger modes described here. Make sure that the operation modes of the frame grabber and the camera are the same.

Image independent ExSync modes:

- **Grabber Controlled**

For the grabber controlled line trigger, the ExSync signal is a simple periodical signal. Its period defines the line frequency and its active time is used by many cameras to define the exposure time.

- **External Trigger**

The external trigger mode for ExSync generates a single ExSync pulse when the external trigger source becomes active. The ExSync defines the exposure time for the camera. During the exposure time is not possible to re-trigger the ExSync. If the camera needs an additional setup time, it is possible to extend the deadtime of the trigger - the time where no re-trigger is possible - beyond the exposure time. If you want to trigger fewer lines than pulses available at the trigger input, it is possible to downscale the trigger input, e.g. a downscaler of 2 will generate an ExSync every 2nd input pulse, a downscaler of 3 only every third of the input pulses, and so on.

Image gate dependent ExSync modes:

- **Grabber Controlled Gated**

For the grabber controlled gated line trigger, the ExSync signal is generated the very same way as for the grabber controlled mode described above. However, the generator for the ExSync is starting the rising image gate and stops with the image gate becoming inactive. This gives a smaller jitter for the time from the start of the image gate and the generation of the first ExSync, especially for very long ExSync periods.

- **External Trigger Gated**

For the external trigger gated controlled line trigger, the ExSync signal is generated the very same way as for the external trigger mode described above. However, the generator for the ExSync is starting the rising image gate and stops with the image gate becoming inactive. For this mode two downscalers are available. The first is the downscaler from the beginning of the image gate to the first ExSync, it is called phase. The second is downscaling all succeeding input triggers and is the same as the downscaler used in external trigger mode described above. The options downscale and phase allow further adjustment of the camera trigger with respect to its external source, the trigger input. The value downscale determines the divisor of the input frequency, e.g. a downscale of 16 will produce an ExSync every $16 * n$ of the input trigger. Furthermore, the phase gives the possibility to shift the camera trigger. A phase shift of 90° is achieved when setting phase to 4, which produces a camera trigger at times $16 * n + 4$ of the input trigger signal.

Table 7.1. Parameter properties of LineTriggerMode

Property	Value	
Name	LineTriggerMode	
Display Name	Line Trigger Mode	
Interface	IEnumeration	
Access policy	Read/Write	
Visibility	Beginner	
Allowed values	GrabberControlled	Grabber Controlled
	AsyncExternalTrigger	Async External Trigger
	GrabberControlledGated	Grabber Controlled Gated
	AsyncGatedTrigger	Async Gated Trigger
Default value	GrabberControlled	

Example 7.1. Usage of LineTriggerMode

```
/* Set */ LineTriggerMode = GrabberControlled;
/* Get */ value_ = LineTriggerMode;
```

7.2. ExSyncOn

This parameter enables the transmission of ExSync signals to the camera.

Please take care to first start the acquisition before setting this ExSyncOn parameter to On (**On**) if you want to acquire all lines being generated by the camera. The signal will be sent as soon as the ExSync has been started. As soon as the acquisition is started the used timeout parameter becomes valid independent of the ExSyncOn parameter being On (**On**) or Off (**Off**). By switching this parameter On (**On**) and Off (**Off**) during an acquisition you can check if the camera is configured to use this external signal for exposure start.

Whether the ExSync is really used by the camera is based on the settings of the camera. Consult the camera's manual for more details because these are device specific.

Table 7.2. Parameter properties of ExSyncOn

Property	Value
Name	ExSyncOn
Display Name	Ex Sync On
Interface	IEnumeration
Access policy	Read/Write/Change
Visibility	Beginner
Allowed values	On On Off Off
Default value	On

Example 7.2. Usage of ExSyncOn

```
/* Set */ ExSyncOn = On;
/* Get */ value_ = ExSyncOn;
```

7.3. LineTriggerInput

In the line trigger input category of the line trigger module, the applet is configured for a possible external line trigger input. Here, debouncing times, downscales, polarities and a shaft encoder input are configured.

The external peripheral line trigger source will be in most cases a shaft encoder, also called a rotary encoder. These devices convert the objects movement over an angular motion into relative incremental pulses. The angular motion is taken from the motor axis or a wheel being connected to the translational motion of the scanned object. For most line scan applications it is relevant to get exact feedback of the relative motion between camera and object. By this a certain number of incremental pulses per distance is given to the frame grabber trigger input interface. Depending on the used incremental shaft encoders a certain number (500, 1000, ...) of incremental pulses per rotation is produced.

Most incremental shaft encoders provide 2 signals that are called A & B. By using these two signals the relative increments can be seen at the edges of these signals and a direction. In one direction the A-phase high state rises before the B-phase in the other direction, i.e. vice versa. If we do not need a direction for our application, only the A-phase is necessary. A combination of A & B may provide a higher resolution. Please see *ShaftEncoderMode* and *ShaftEncoderOn* for this.

Figure 7.1. Shaft Encoder, A & B phase, direction

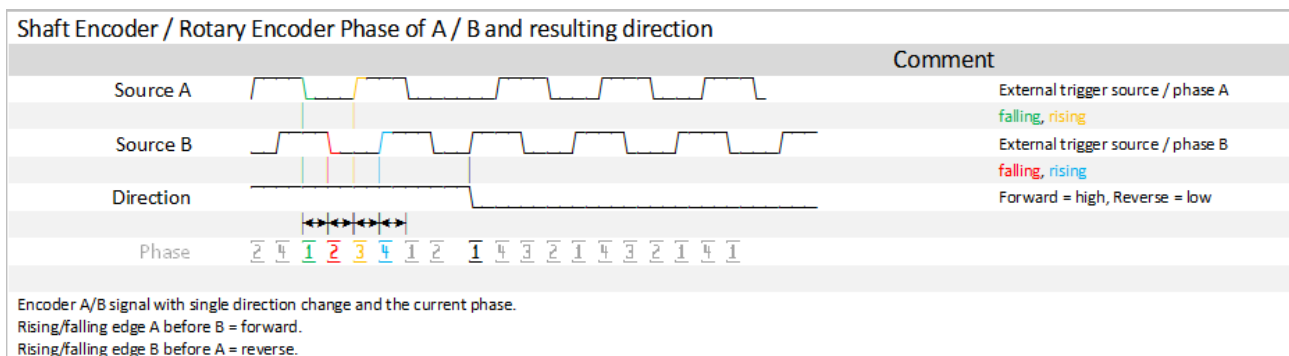

During an acquisition the shaft encoder signals trigger the ExSync signals and force the sensor to perform an exposure. After the sensor exposure the line is read-out and transferred. The time between exposure and transfer is for most line scan cameras very short.

Figure 7.2. Shaft Encoder, A & B signal, acquisition

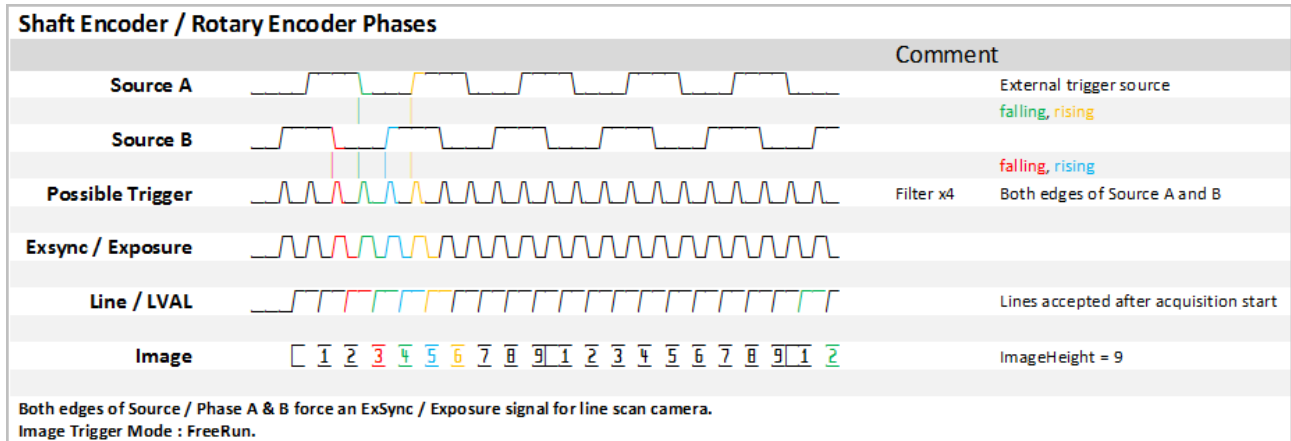

The different phases are defined as seen in the following table. A positive phase increment is forward direction, a negative means reverse. This induces rising/falling edge A before B equals forward direction and rising/falling edge B before A means reverse.

Table 7.3. Phases of an A/B Shaft Encoder

Phase	A-state	B-state
1	low	high
2	low	low
3	high	low
4	high	high

Some shaft encoders provide a third signal that is pulsed for each full rotation which is called Z or index. This signal Z could become interesting for an image trigger mode. For more details see Chapter 8, 'ImageTriggerFlash'.

For most applications and several camera or line scan sensor types it is necessary to have the same resolution in X and Y direction of an image. Due to this the number of pixels per mm in sensor- and motion-direction needs to be the same. In case of an 1024 pixel line scan sensor looking at 10 cm we have 10.24 pixel per mm orthogonal to the web direction. In order to reach an 1:1 scaling we need 10.24 ExSync signals per mm. If a perfectly round object is scanned with an 1:1 scaling then it is exactly round in the image too. When the result becomes elliptic, the scaling is not perfect and some line scan sensor architectures (Bi/Tri-Linear, Dual-Line, ...) will show some additional artefacts.

7.3.1. LineTriggerInSource

This parameter specifies the digital signal source for phase A, which is used to trigger the ExSync signal. If an A/B shaft encoder is used, configure source B at *ShaftEncoderInputSource*, too. For more details consult the Framegrabber SDK manual.

It is possible to use the shaft encoder A phase only if the direction of scanning is not of interest in the target application. Concerning more details to the shaft encoder please consider the introduction of Section 7.3, 'LineTriggerInput'.

Table 7.4. Parameter properties of LineTriggerInSource

Property	Value
Name	LineTriggerInSource
Display Name	Line Trigger In Source
Interface	IEnumeration
Access policy	Read/Write/Change
Visibility	Beginner
Allowed values	GPITriggerSource0 GPI Trigger Source 0 GPITriggerSource1 GPI Trigger Source 1 GPITriggerSource2 GPI Trigger Source 2 GPITriggerSource3 GPI Trigger Source 3 GPITriggerSource4 GPI Trigger Source 4 GPITriggerSource5 GPI Trigger Source 5 GPITriggerSource6 GPI Trigger Source 6 GPITriggerSource7 GPI Trigger Source 7 TriggerInSourceFrontGPI0 Trigger In Source Front GPI 0 TriggerInSourceFrontGPI1 Trigger In Source Front GPI 1 TriggerInSourceFrontGPI2 Trigger In Source Front GPI 2 TriggerInSourceFrontGPI3 Trigger In Source Front GPI 3
Default value	GPITriggerSource1

Example 7.3. Usage of LineTriggerInSource

```
/* Set */ LineTriggerInSource = GPITriggerSource1;
/* Get */ value_ = LineTriggerInSource;
```

7.3.2. LineTriggerInPolarity

The parameter defines the polarity of the external input trigger signal encoder source A and source B. When set to *LowActive*, the ExSync generator starts on a falling edge of the signal specified by the parameter *LineTriggerInSource*. Otherwise, the ExSync generation starts on a rising edge. This is only relevant if the *LineTriggerMode* is set to an external trigger.

Table 7.5. Parameter properties of LineTriggerInPolarity

Property	Value
Name	LineTriggerInPolarity
Display Name	Line Trigger In Polarity
Interface	IEnumeration
Access policy	Read/Write/Change
Visibility	Beginner
Allowed values	LowActive Low Active HighActive High Active
Default value	HighActive

Example 7.4. Usage of LineTriggerInPolarity

```
/* Set */ LineTriggerInPolarity = HighActive;
/* Get */ value_ = LineTriggerInPolarity;
```

7.3.3. LineTriggerDebouncing

This parameter specifies the debouncing time. This is the time for which the input line trigger signals must keep the same value to be detected as such. Fast signal changes within the debouncing time will be filtered out.

Table 7.6. Parameter properties of LineTriggerDebouncing

Property	Value
Name	LineTriggerDebouncing
Display Name	Line Trigger Debouncing
Interface	IFloat
Access policy	Read/Write/Change
Visibility	Beginner
Allowed values	Minimum 0.0032 Maximum 26.0 Stepsize 0.0032
Default value	0.112
Unit of measure	µs

Example 7.5. Usage of LineTriggerDebouncing

```
/* Set */ LineTriggerDebouncing = 0.112;
/* Get */ value_ = LineTriggerDebouncing;
```

7.3.4. Downscale

7.3.4.1. LineDownscale

Sets the value after how many pulses of the input trigger signal a single one is passed through as ExSync. For example, a value of 2 creates an ExSync pulse at each 2nd input trigger signal. This is only relevant if the *LineTriggerMode* is set to an external trigger mode. The parameter *LineDownscaleInit* selects an initial delay of incoming pulses.

Figure 7.3. Downscale and Init phase behaviour

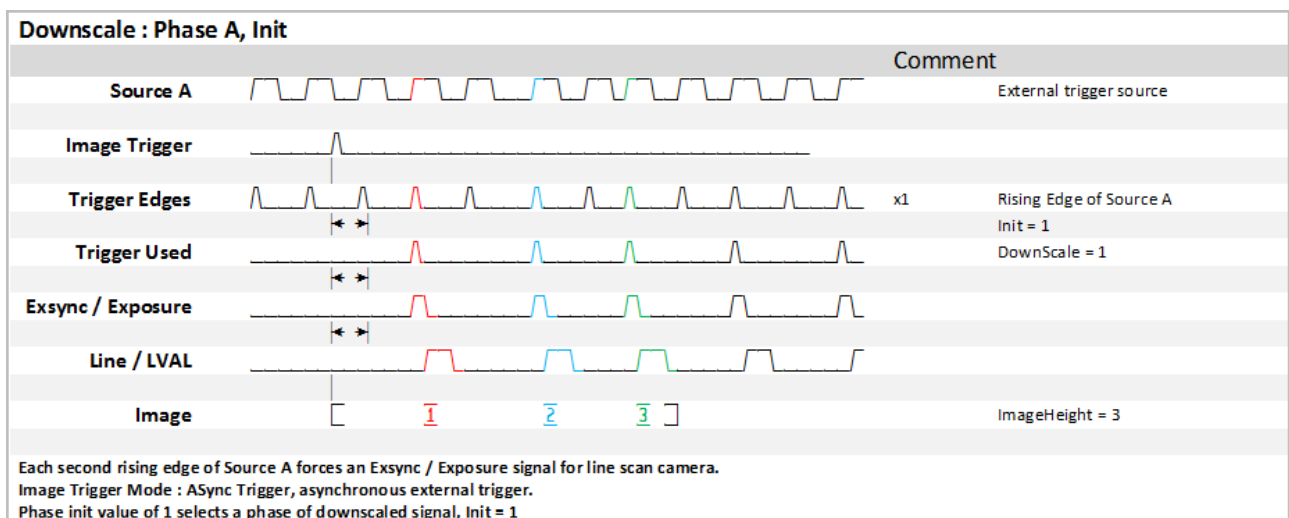

Table 7.7. Parameter properties of LineDownscale

Property	Value
Name	LineDownscale
Display Name	Line Downscale
Interface	IInteger
Access policy	Read/Write
Visibility	Beginner
Allowed values	Minimum 1 Maximum 255 Stepsize 1
Default value	1
Unit of measure	pulses

Example 7.6. Usage of LineDownscale

```
/* Set */ LineDownscale = 1;
/* Get */ value_ = LineDownscale;
```

7.3.4.2. LineDownscaleInit

In addition to the downscale value this parameter sets a phase position. This parameter specifies the number of external input trigger signals, which are needed to generate the first ExSync of a frame. This is only relevant if the *LineTriggerMode* is set to an image gate dependent ExSync mode. This value is applied after the image start pulse. The parameter *LineDownscale* represents the number of possible steps and an explaining figure is found in its description (Init=1).

Table 7.8. Parameter properties of LineDownscaleInit

Property	Value
Name	LineDownscaleInit
Display Name	Line Downscale Init
Interface	IInteger
Access policy	Read/Write
Visibility	Beginner
Allowed values	Minimum 1 Maximum 255 Stepsize 1
Default value	1
Unit of measure	pulses

Example 7.7. Usage of LineDownscaleInit

```
/* Set */ LineDownscaleInit = 1;
/* Get */ value_ = LineDownscaleInit;
```

7.4. ShaftEncoderABFilter

With the support of signal A/B for shaft encoders it is possible to detect the rotary direction of an attached encoder and filter the encoder signals accordingly. Also a compensation is performed for up to 16,777,216 reverse encoder signals. A brief description about this feature is found in the shaft encoder documentation.

7.4.1. ShaftEncoderOn

Switch the shaft encoder filter On or Off. This is only relevant if the *LineTriggerMode* is set to an external trigger mode. The functionalities of *ShaftEncoderMode*, *ShaftEncoderInputSource*, *ShaftEncoderLeading*, *ShaftEncoderCompensationEnable*, *ShaftEncoderCompensationCount* become relevant in the case this parameter is set to On = **On**. When enabling the shaft encoder, a reset of the encoder compensation is performed. If this filter is switched on an correct A & B encoder signal is expected and necessary for correct functionality. Please be aware that the input signal at *ShaftEncoderInputSource* is interpreted as phase B and the input signal at *LineTriggerInSource* as phase A. A sketch of the signal can be found in the description of parameter *LineTriggerInSource*.

Table 7.9. Parameter properties of ShaftEncoderOn

Property	Value
Name	ShaftEncoderOn
Display Name	Shaft Encoder On
Interface	IEnumeration
Access policy	Read/Write/Change
Visibility	Beginner
Allowed values	On On Off Off
Default value	Off

Example 7.8. Usage of ShaftEncoderOn

```
/* Set */ ShaftEncoderOn = 0ff;
/* Get */ value_ = ShaftEncoderOn;
```

7.4.2. ShaftEncoderMode

The shaft encoder mode can be run in three operation modes. Please choose the according operation mode for your application. This feature can be used if *ShaftEncoderOn* is switched on. It enables you to adjust the number of increments per rotation of the shaft encoder. Together with the parameter *LineDownscale* you can adjust the increment re-scaling.

The following modes are available:

- Filter x1

ExSync is generated for a forward rotation of the shaft encoder in single resolution, i.e. a trigger pulse for rising edge of Source A.

- Filter x2

ExSync is generated for a forward rotation of the shaft encoder in double resolution, i.e. a trigger pulse for a rising and falling edge of Source A, edges of Source B are not used.

- Filter x4

ExSync is generated for a forward rotation of the shaft encoder in quad resolution, i.e. a trigger pulse for a rising and falling edge of Source A and a rising and falling edge of Source B.

Figure 7.4. Shaft Encoder Mode : Filter x4, x2, x1

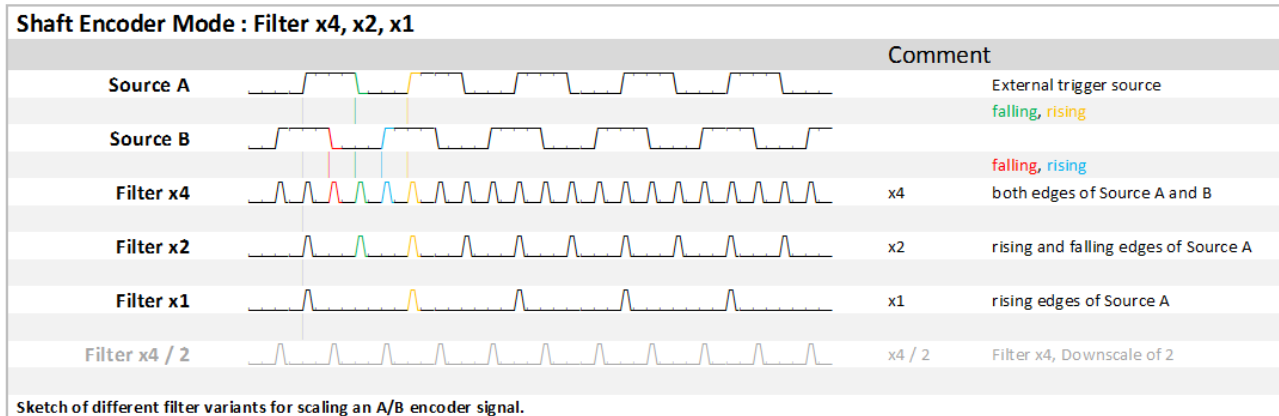

Table 7.10. Parameter properties of ShaftEncoderMode

Property	Value
Name	ShaftEncoderMode
Display Name	Shaft Encoder Mode
Interface	IEnumeration
Access policy	Read/Write/Change
Visibility	Beginner
Allowed values	FilterX1 Filter X1 FilterX2 Filter X2 FilterX4 Filter X4
Default value	FilterX1

Example 7.9. Usage of ShaftEncoderMode

```
/* Set */ ShaftEncoderMode = FilterX1;
/* Get */ value_ = ShaftEncoderMode;
```

7.4.3. ShaftEncoderInputSource

Specifies the input signal source / phase B for the shaft encoder filter. Signal source B of the shaft encoder is 90 degree phase shifted to source / phase A. In this document you can get more explanations regarding the input pins in the context of parameter *LineTriggerInSource* and concerning the shaft encoder in the introduction of Section 7.3, 'LineTriggerInput'. Check the hardware documentation of the microEnable trigger board and the Framegrabber SDK manual for more details.

Table 7.11. Parameter properties of ShaftEncoderInputSource

Property	Value
Name	ShaftEncoderInputSource
Display Name	Shaft Encoder Input Source
Interface	IEnumeration
Access policy	Read/Write/Change
Visibility	Beginner
Allowed values	GPITriggerSource0 GPI Trigger Source 0 GPITriggerSource1 GPI Trigger Source 1 GPITriggerSource2 GPI Trigger Source 2 GPITriggerSource3 GPI Trigger Source 3 GPITriggerSource4 GPI Trigger Source 4 GPITriggerSource5 GPI Trigger Source 5 GPITriggerSource6 GPI Trigger Source 6 GPITriggerSource7 GPI Trigger Source 7 TriggerInSourceFrontGPI0 Trigger In Source Front GPI 0 TriggerInSourceFrontGPI1 Trigger In Source Front GPI 1 TriggerInSourceFrontGPI2 Trigger In Source Front GPI 2 TriggerInSourceFrontGPI3 Trigger In Source Front GPI 3
Default value	GPITriggerSource2

Example 7.10. Usage of ShaftEncoderInputSource

```
/* Set */ ShaftEncoderInputSource = GPITriggerSource2;
/* Get */ value_ = ShaftEncoderInputSource;
```

7.4.4. ShaftEncoderLeading

This parameter defines the leading signal (= direction) of the shaft encoder filter. This induces rising/falling edge A before B equals forward direction and rising/falling edge B before A means reverse. The default setting is A as the leading signal. Flipping the input pins or their polarity will have the same effect as changing this to B as the leading signal. It simply defines the valid direction of the scan. An explanation of the direction detection based on an encoder A / B signal is found in Section 7.3, 'LineTriggerInput'.

Table 7.12. Parameter properties of ShaftEncoderLeading

Property	Value
Name	ShaftEncoderLeading
Display Name	Shaft Encoder Leading
Interface	IEnumeration
Access policy	Read/Write/Change
Visibility	Beginner
Allowed values	SourceA Source A SourceB Source B
Default value	SourceA

Example 7.11. Usage of ShaftEncoderLeading

```
/* Set */ ShaftEncoderLeading = SourceA;
/* Get */ value_ = ShaftEncoderLeading;
```

7.4.5. ShaftEncoderCompensationEnable

The shaft encoder analyzer includes a rollback compensation. In case the rollback compensation is enabled, the module will compensate the reverse movement so that no object is scanned twice. The module will count the number of reverse pulses and will suppress all reverse and forward pulses until position of maximum progress is reached again. If switched to ON, in case of shaft encoder backward movement, the operator counts how many shaft encoder steps the shaft encoder moves backwards. When the shaft encoder moves forwards again, this number of shaft encoder steps (now forward direction) is not transmitted as external trigger signals. Only after the transportation belt is back to the place where the backward movement started, the shaft encoder steps (forward direction) are transmitted as external trigger signals again.

Parameter *ShaftEncoderCompensationEnable* switched ON:

Figure 7.5. Shaft Encoder Compensation Enable = ON

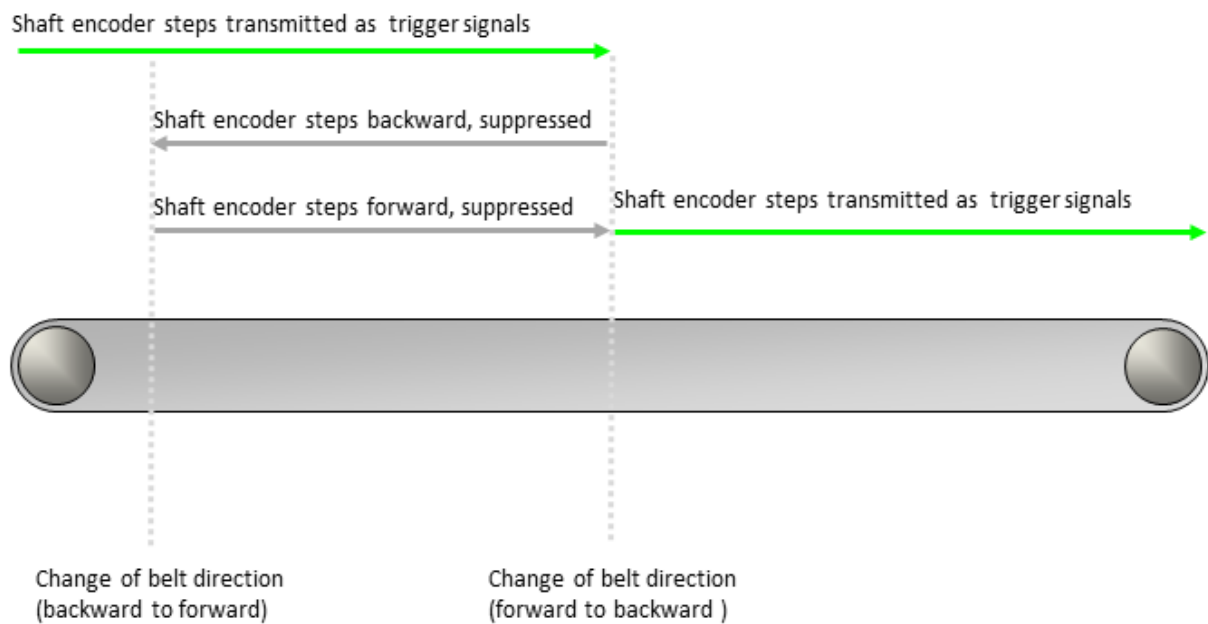

In case the rollback compensation is disabled, the shaft encoder analyzer will only suppress reverse pulses but use all forward pulses. If switched to OFF, the operator simply doesn't transmit any trigger signals as long as the transportation belt moves backwards. As soon as the transport belt starts to move forwards again, the operator transmits the shaft encoder steps (forward direction) as trigger signals.

Parameter *ShaftEncoderCompensationEnable* switched OFF:

Figure 7.6. Shaft Encoder Compensation Enable = OFF

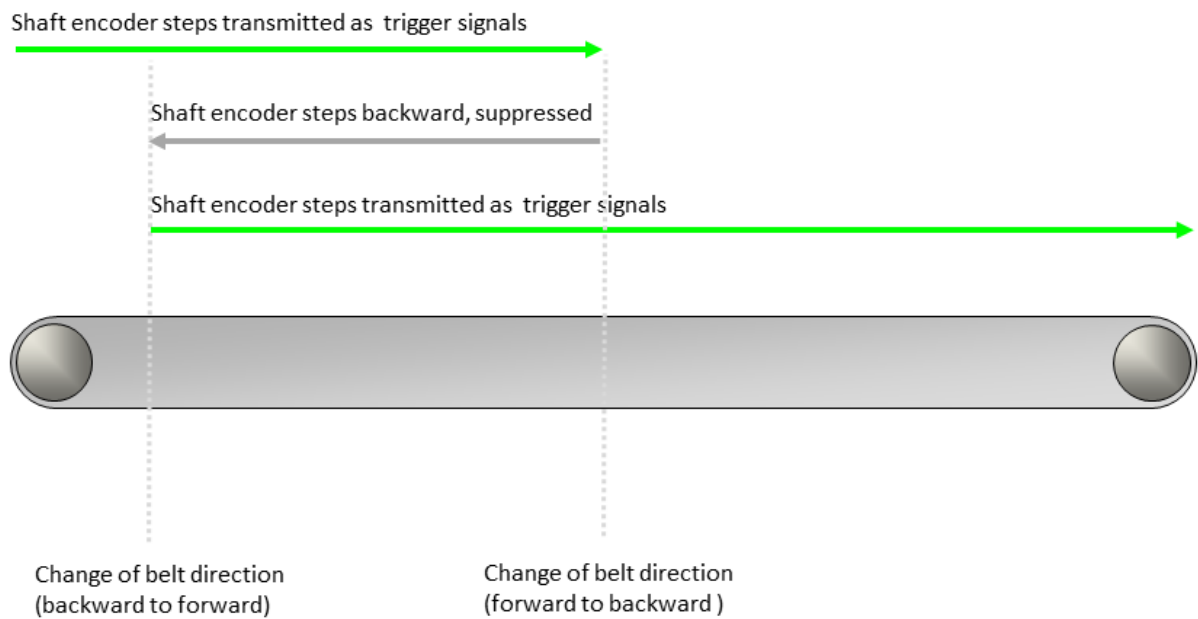

Table 7.13. Parameter properties of ShaftEncoderCompensationEnable

Property	Value
Name	ShaftEncoderCompensationEnable
Display Name	Shaft Encoder Compensation Enable
Interface	IEnumeration
Access policy	Read/Write/Change
Visibility	Beginner
Allowed values	On On Off Off
Default value	On

Example 7.12. Usage of ShaftEncoderCompensationEnable

```
/* Set */ ShaftEncoderCompensationEnable = On;
/* Get */ value_ = ShaftEncoderCompensationEnable;
```

7.4.6. ShaftEncoderCompensationCount

Using this parameter you can read and write the current shaft encoder rollback compensation counter. A compensation value zero indicates that currently no compensation is made. Therefore, you can reset the compensation by writing value zero to this parameter. Any other value will set a new compensation value. By knowing the distance / resolution for every encoder pulse, the compensation distance can be set. Concerning the shaft encoder find some more details in the introduction of Section 7.3, 'LineTriggerInput'.

It is based on a 20bit counter enabling a backward movement of up to 1048575 encoder pulses. An overflow of this value will not occur since it will skip all additional pulses for a compensation state of more than 1048575. By this the count of the rollback compensation is limited by 2 to the power of 20 pulses, what is enough for most applications in practice. As an example we could use a pretty high resolution of 20 pulses per mm, what is already sufficient for a maximum rollback distance of more than 50 meters.

Basic Conditions

If parameter *ShaftEncoderCompensationEnable* is set to ON, an internal counter counts the shaft encoder steps the transportation belt moves backwards. This is necessary to be able to compensate the exact number of shaft encoder steps when the transportation belt starts moving forwards again:

Figure 7.7. Shaft Encoder Compensation Enable = ON

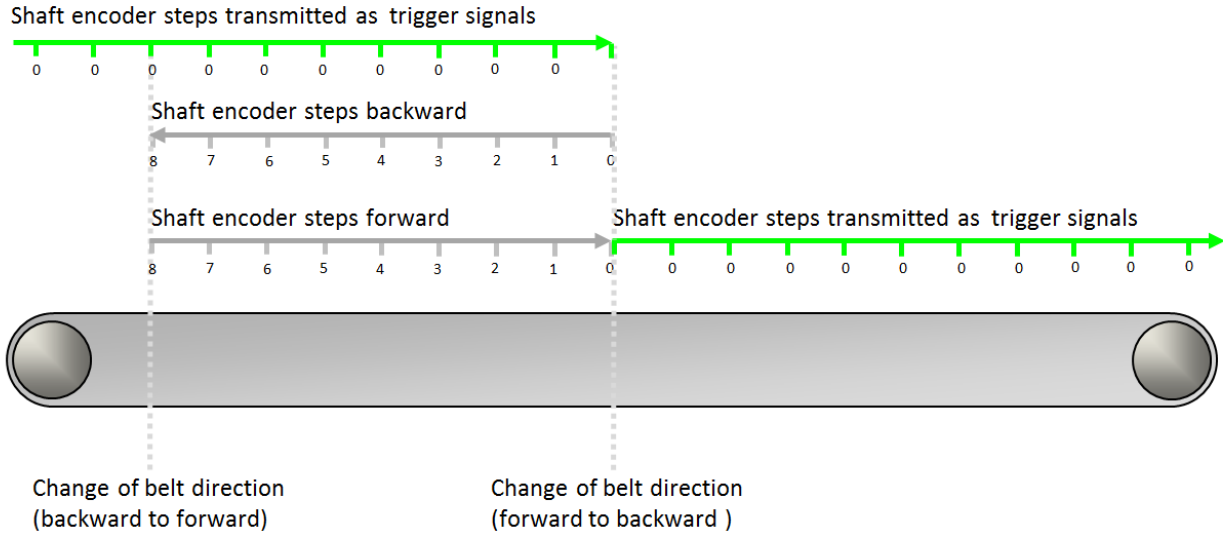

The internal counter counts forwards as long as the transportation belt moves backwards. (In figure 7.7, from 0 to 8.)

The internal counter counts backwards while the transportation belt moves forwards. (In figure 7.7, from 8 to 0.)

When the internal counter holds the value 0, the shaft encoder steps are transmitted as trigger signals.

The value the internal counter holds at a given moment is the value of parameter *ShaftEncoderCompensationCount*. Only if this value is 0, encoder steps are transmitted as trigger signals. If the value of parameter *ShaftEncoderCompensationCount* is not 0, the shaft encoder steps are not transmitted as trigger signals and the value keeps changing with every encoder step until it reaches the value 0 again.

Reading the Parameter

The parameter *ShaftEncoderCompensationCount* is a read/write parameter. Therefore, at any given moment, you can always read out the value the counter holds at a given moment.

Defining an Offset

On the other hand, you can always modify the parameter value since you have write access during acquisition. If you need to define an offset to the standard encoder compensation, you can use this parameter to enter the number of steps you need the offset to be.

As soon as you enter a value for *ShaftEncoderCompensationCount*, this value overwrites the value the parameter holds before.

In the following let's look at some examples for overwriting the current value of *ShaftEncoderCompensationCount*:

Example 1:

The transportation belt is moving forward, the shaft encoder steps are transmitted as trigger signals, and the value of *ShaftEncoderCompensationCount* is 0. Then, the value 0 of *ShaftEncoderCompensationCount* is overwritten by value 4. Result: 4 shaft encoder steps are not transmitted as trigger signals.

Figure 7.8. Shaft Encoder Compensation Count Example 1

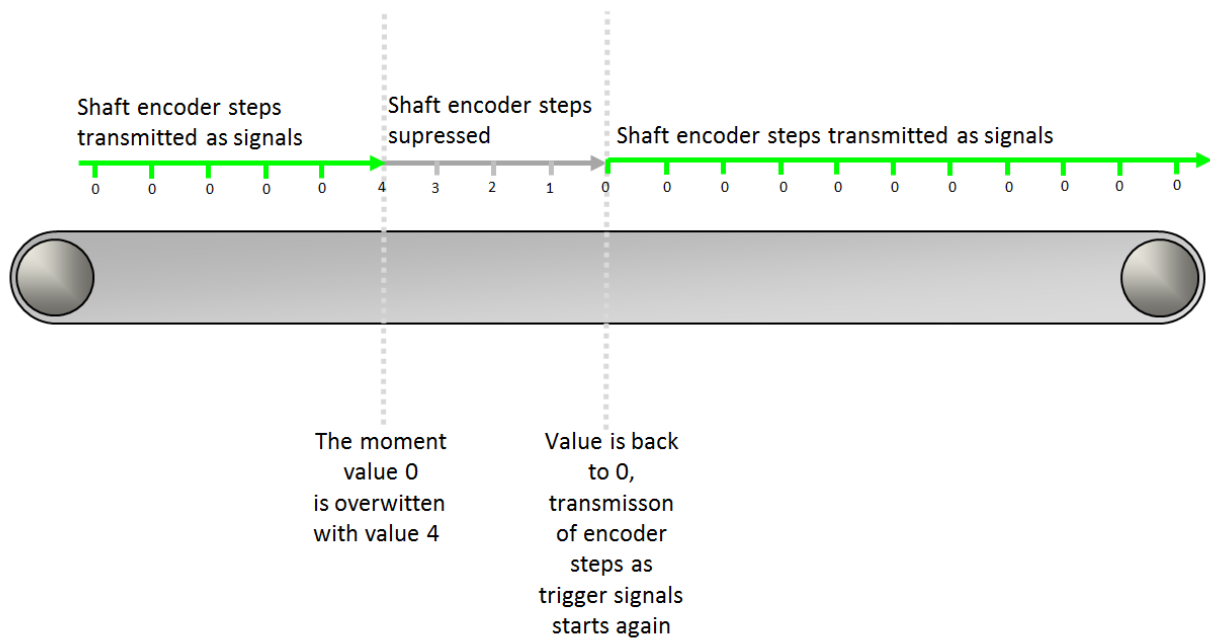
**Example 2:**

The transportation belt is moving backward, the (backward) shaft encoder steps are suppressed, and the value of *ShaftEncoderCompensationCount* is not 0. Then, during backward movement of the transportation belt, the value 5 of *ShaftEncoderCompensationCount* is overwritten by value 7. Result: Offset of 2 shaft encoder steps.

Figure 7.9. Shaft Encoder Compensation Count Example 2

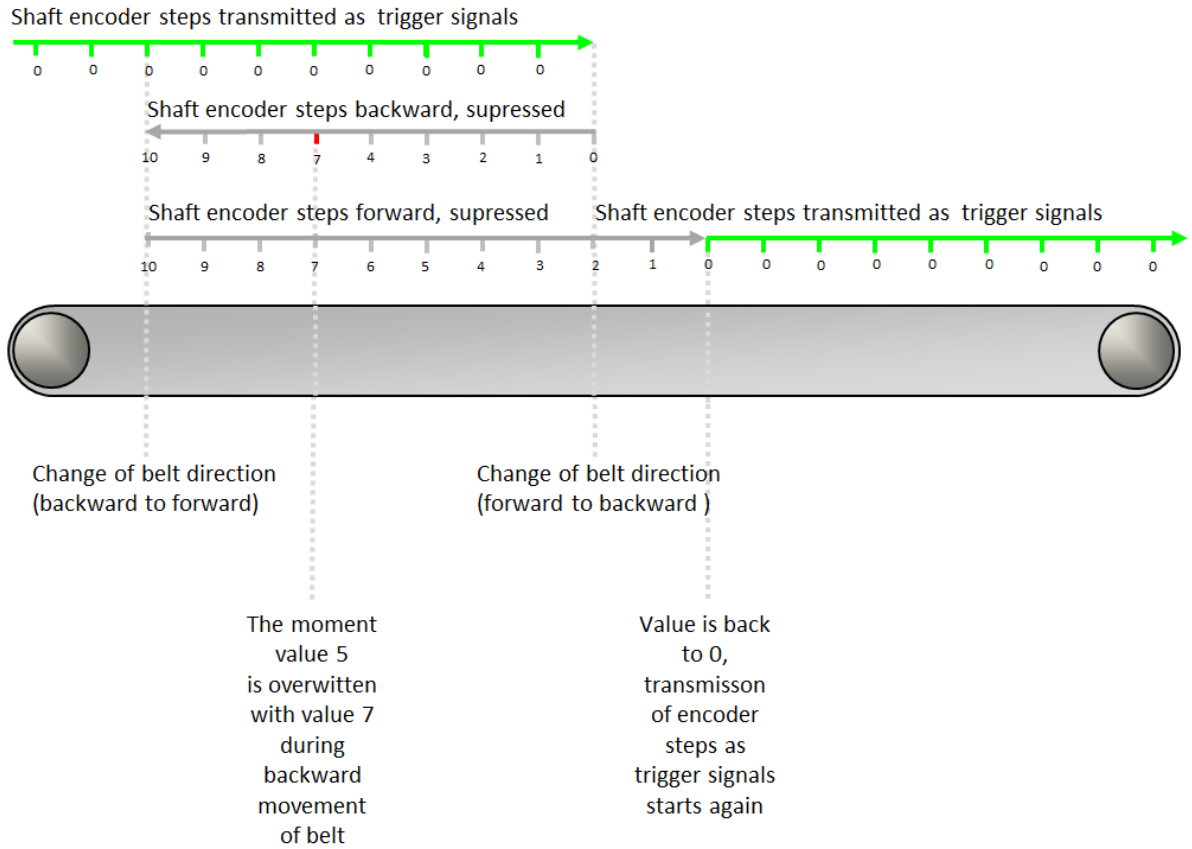

Example 3:

The transportation belt is moving forward during compensation, the (forward) shaft encoder steps are suppressed, and the value of *ShaftEncoderCompensationCount* is not 0. Then, during compensative forward movement of the transportation belt, the value 4 of *ShaftEncoderCompensationCount* is overwritten with value 9. Result: Offset of 5 shaft encoder steps.

Figure 7.10. Shaft Encoder Compensation Count Example 3

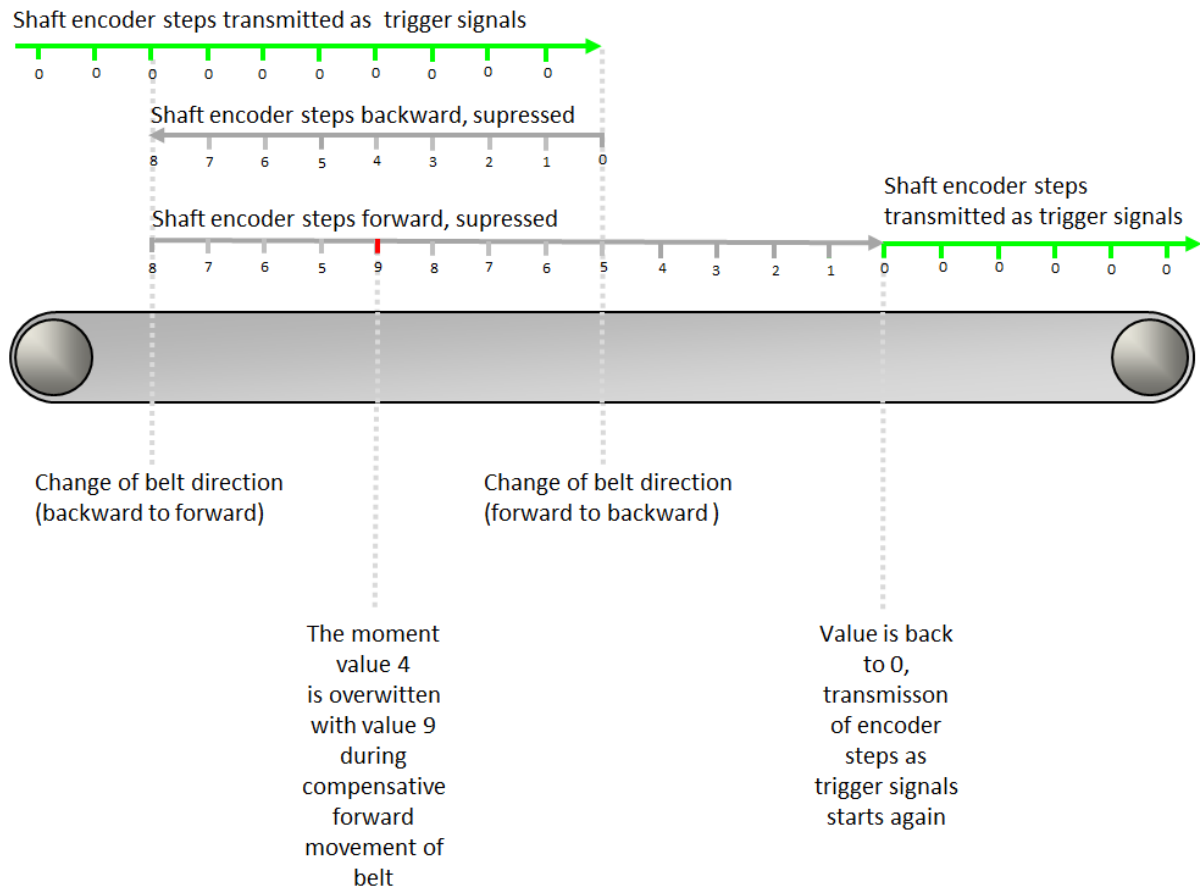
**Example 4:**

The transportation belt is moving forward during compensation, the (forward) shaft encoder steps are suppressed, and the value of *ShaftEncoderCompensationCount* is not 0. Then, during compensative forward movement of the transportation belt, the value 4 of *ShaftEncoderCompensationCount* is overwritten with a smaller value, in our case with value 3. Result: Negative offset of -1 shaft encoder step.

Figure 7.11. Shaft Encoder Compensation Count Example 4

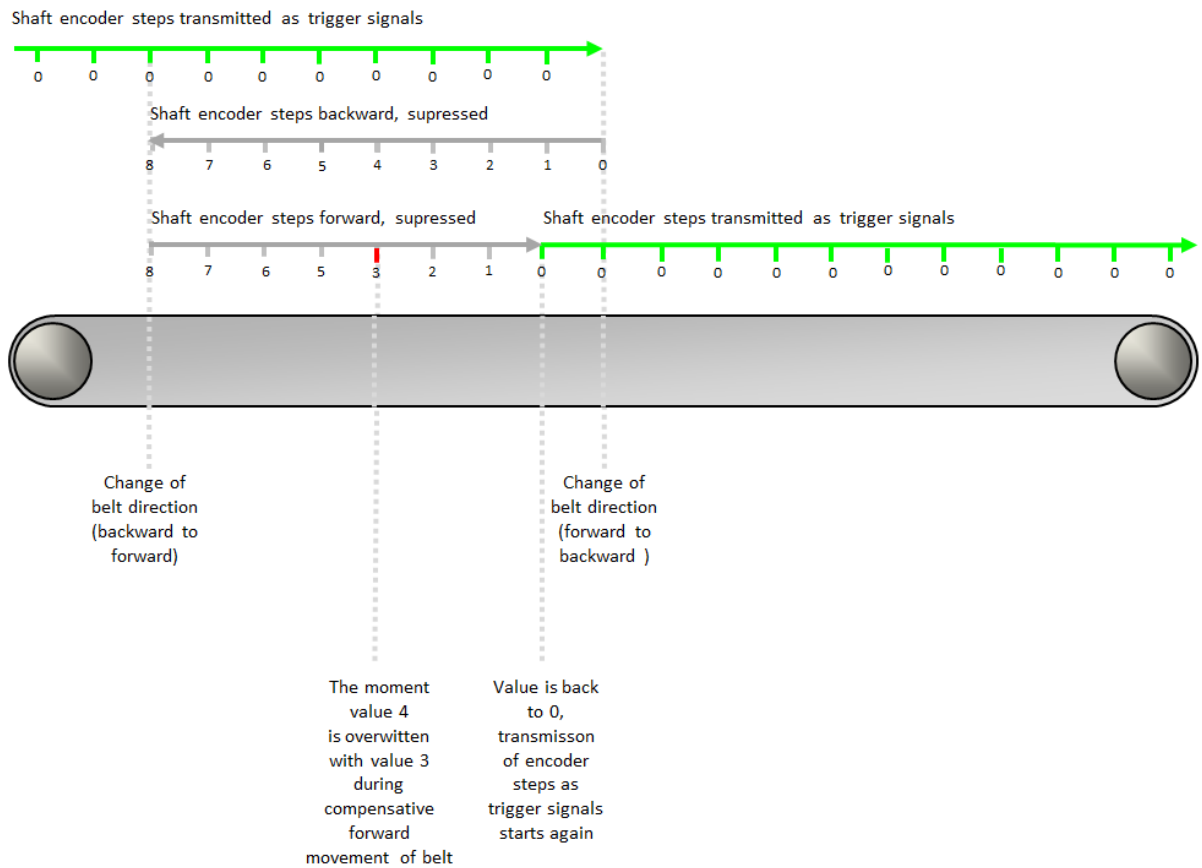

Table 7.14. Parameter properties of ShaftEncoderCompensationCount

Property	Value
Name	ShaftEncoderCompensationCount
Display Name	Shaft Encoder Compensation Count
Interface	IInteger
Access policy	Read/Write/Change
Visibility	Beginner
Allowed values	Minimum 0 Maximum 1048575 Stepsize 1
Default value	0
Unit of measure	pulses

Example 7.13. Usage of ShaftEncoderCompensationCount

```
/* Set */ ShaftEncoderCompensationCount = 0;
/* Get */ value_ = ShaftEncoderCompensationCount;
```

7.5. ExSyncOutput

This category includes parameters to specify and parameterize the generated ExSync output signals.

7.5.1. LinePeriod

This parameter specifies the period of the ExSync signal. Therefore, it defines the line frequency when using the grabber controlled mode to trigger the connected camera. This period is of interest if a grabber controlled line trigger mode is used; more details for this can be found at *LineTriggerMode*. The line period is not allowed to be shorter than the minimum period - maximum line frequency - being supported by the camera, or in other words:

Please do not try to trigger the camera at a higher frequency than possible.

This maximum frequency is limited by the exposure time and the line scan sensor maximum speed. Please consider the camera manual for more details.

The following equations are mentioned in order to support the setup process if no period for *LinePeriod* is mentioned:

- **Frequency**

The period **T** is the duration of time of one cycle in a repeating event, so the period is the reciprocal of the frequency **f**.

Equation 7.1. Frequency to Period

$$T = \frac{1}{f}$$

Equation 7.2. Example: 17.6 kHz to Period

$$\begin{aligned} T &= \frac{1}{F} = \frac{1}{17.6kHz} = \frac{1}{17600Hz} \\ T &= 0.0000568s = 0.0568ms = 56.8\mu s \end{aligned}$$

- **Velocity and Pixel / mm**

The period **T** is the duration of time of one cycle in a repeating event. At a velocity **v** and a given number **n** of pixels / mm together with the number **n** of pixels / mm being based on the resolution count **r** of the line scan sensor pixels and the width of view **w** in mm the following equations are valid.

Equation 7.3. Velocity and Resolution to Period

$$\begin{aligned} n &= \frac{r}{w} \\ v &= \frac{\text{distance}}{\text{time}} \\ f &= v * n \\ T &= \frac{1}{f} \end{aligned}$$

Equation 7.4. Example: v = 53.4 m/min, r = 4096 pixels, w = 19.2 cm Wide Web to Period

$$\begin{aligned} n &= \frac{r}{w} = \frac{4096}{19.2cm} = \frac{4096}{192mm} = \frac{21.33}{mm} \\ v &= \frac{\text{distance}}{\text{time}} = \frac{53.4m}{min} = \frac{53.4m}{60s} = 0.89 \frac{m}{s} \\ f &= v * n = 0.89 \frac{m}{s} * \frac{21.33}{mm} = 890 \frac{mm}{s} * \frac{21.33}{mm} \\ &= \frac{890 * 21.33}{s} = \frac{18983.7}{s} = 18983.7Hz = 18.9837kHz \\ T &= \frac{1}{f} \\ &= \frac{1}{18983.7Hz} = 52.68\mu s \end{aligned}$$

Table 7.15. Parameter properties of LinePeriod

Property	Value
Name	LinePeriod
Display Name	Line Period
Interface	IFloat
Access policy	Read/Write/Change
Visibility	Beginner
Allowed values	Minimum 0.2048 Maximum 838.8576 Stepsize 0.0032
Default value	200.0
Unit of measure	µs

Example 7.14. Usage of LinePeriod

```
/* Set */ LinePeriod = 200.0;
/* Get */ value_ = LinePeriod;
```

7.5.2. LineExposure

This parameter specifies the pulse width of the ExSync signal, which can be used by many cameras to specify the exposure time. It is possible to adjust the exposure time via software, even while grabbing. The value is set in microseconds and may not exceed the period time of the ExSync *LinePeriod*. In order to check the polarity simply increase this value and the resulting frame should become brighter. If this behaves in an opposite way check the polarity using *ExSyncPolarity*.

Table 7.16. Parameter properties of LineExposure

Property	Value
Name	LineExposure
Display Name	Line Exposure
Interface	IFloat
Access policy	Read/Write/Change
Visibility	Beginner
Allowed values	Minimum 0.2048 Maximum 419.4272 Stepsize 0.0032
Default value	19.0
Unit of measure	µs

Example 7.15. Usage of LineExposure

```
/* Set */ LineExposure = 19.0;
/* Get */ value_ = LineExposure;
```

7.5.3. ExSyncPolarity

The parameter adjusts the polarity of the ExSync signal generator. Use Low Active, if the camera opens the shutter on a falling edge, otherwise use High Active. For the mapping of the ExSync signals to the digital outputs check Chapter 6, '*DigitalIO*'.

Table 7.17. Parameter properties of ExSyncPolarity

Property	Value
Name	ExSyncPolarity
Display Name	Ex Sync Polarity
Interface	IEnumeration
Access policy	Read/Write/Change
Visibility	Beginner
Allowed values	LowActive Low Active HighActive High Active
Default value	HighActive

Example 7.16. Usage of ExSyncPolarity

```
/* Set */ ExSyncPolarity = HighActive;
/* Get */ value_ = ExSyncPolarity;
```

7.5.4. LineTriggerDelay

This parameter specifies the delay between the generated ExSync and ExSync2 signals with respect to an external trigger input. Therefore, the ExSync2 signal is a delayed clone of the ExSync (polarity, period, etc. are the same as for ExSync). For the mapping of the ExSync signals to the digital outputs check Chapter 6, 'DigitalIO'.

Please note that the line trigger delay needs to be less than the line trigger period. You might need to increase the line period first before increasing the line delay. This constraint also applies for external line trigger modes.

Table 7.18. Parameter properties of LineTriggerDelay

Property	Value
Name	LineTriggerDelay
Display Name	Line Trigger Delay
Interface	IFloat
Access policy	Read/Write/Change
Visibility	Beginner
Allowed values	Minimum 0.0 Maximum 419.4272 Stepsize 0.0032
Default value	0.0
Unit of measure	µs

Example 7.17. Usage of LineTriggerDelay

```
/* Set */ LineTriggerDelay = 0.0;
/* Get */ value_ = LineTriggerDelay;
```

Chapter 8. ImageTriggerFlash

The image trigger for line-scan cameras is in charge to generate an internal signal called image gate. Lines sent by the camera are only accepted if this image gate is active = open. Therefore, with help of the Image Gate it is possible to define frames by grouping all lines that belong to the same image gate into one frame.

This AcquisitionApplets supports three distinct operation modes of the image trigger:

- Free run

In free run mode the image gate basically remains active all time. Therefore, all lines sent by the camera are grabbed. Moreover, it cuts the input lines into frames of the height specified by parameter *Height* of the display module. Also, offsets defined by *OffsetY* are covered and removed from the camera transfers for each image.

- Async Trigger

For the external trigger mode of the image trigger, the image gate is inactive = closed until an external trigger signal activates the image gate for *Height + OffsetY* lines. Therefore, for each external trigger event, the frame grabber records a frame of the specified height.

- Async Trigger Multi Buffer

For the external trigger mode of the image trigger, the image gate is inactive = closed until an external trigger signal activates the image gate. In contrast to the **AsyncExternalTrigger** mode, the gate is open for *ImageTriggerAsyncHeight* lines while this image is split into smaller chunks of *Height* lines. Therefore, for each external trigger event, the frame grabber records a frame of a large specified height and split the large image into smaller chunks. The purpose of the mode is to start processing in PC while the image is still recorded.

The parameter value of *OffsetY* is without influence in this mode.

- Gated, Trigger

For the external gated mode of the image trigger, the image gate is active as long as the external trigger source is active, but is becoming inactive when *Height + OffsetY* lines have been grabbed. Therefore, during an external trigger phase the frame grabber records a frame with a height depending on the duration of active time of the external trigger signal, but is not exceeding an image height of *Height + OffsetY* lines.

- Gated Multi Buffer, Triggered

Equal to the 'Gated Trigger' mode, for the 'Gated Multi Buffer Trigger' the image gate is active as long as the external trigger source is active. In contrast, it does not limit the height to *Height* lines. It will cut the image after *Height* lines and start a new frame. Thus, for each gate, multiple frames are generated when a gate is active for more lines than defined by *Height*.

All images of a generated sequence will have a height of *Height* lines. However, the last image of each sequence might have a lower number of lines in the image.

To detect the last image of a sequence in your software. Parameter **FG_IMAGE_TAG** can be used. This parameter is of type unsigned 32 bit integer. The most significant bit i.e. bit 31 includes a flag which is set to one if the respective image is the last image of a multi buffer sequence.

```
uint32_t imageTag = 0;
int returnCode = Fg_getParameterEx(fg, FG_IMAGE_TAG, &imageTag, 0, pmem0, imageNumber);
bool isLastImageOfSequence = imageTagRAW >> 31;
```

All other bits of parameter **FG_IMAGE_TAG** are fixed to value 0. The image tag parameter does not output the image number as available for older AcquisitionApplets.

Note that the value of parameter *OffsetY* is not considered if the 'Gated Multi Buffer Trigger' mode is used. An y-offset cannot be set in the applet.

8.1. ImageTriggerMode

Choose one of the image trigger modes described above. Please make sure that the operation mode of frame grabber and camera is the same.

Table 8.1. Parameter properties of ImageTriggerMode

Property	Value
Name	ImageTriggerMode
Display Name	Image Trigger Mode
Interface	IEnumeration
Access policy	Read/Write
Visibility	Beginner
Allowed values	freeRun Free Run AsyncExternalTrigger Async External Trigger AsyncExternalTriggerMultiframe Async External Trigger Multiframe AsyncGatedTrigger Async Gated Trigger AsyncGatedTriggerMultiframe Async Gated Trigger Multiframe
Default value	freeRun

Example 8.1. Usage of ImageTriggerMode

```
/* Set */ ImageTriggerMode = freeRun;
/* Get */ value_ = ImageTriggerMode;
```

8.2. ImageTriggerOn

The generation of image triggers can be switched on or off by use of this parameter. When the image trigger is disabled and the image trigger is not running in free-run mode, the image acquisition is terminated. If the image trigger is enabled, the acquisition will start immediately.

Table 8.2. Parameter properties of ImageTriggerOn

Property	Value
Name	ImageTriggerOn
Display Name	Image Trigger On
Interface	IEnumeration
Access policy	Read/Write/Change
Visibility	Beginner
Allowed values	On On Off Off
Default value	On

Example 8.2. Usage of ImageTriggerOn

```
/* Set */ ImageTriggerOn = On;
/* Get */ value_ = ImageTriggerOn;
```

8.3. FlashOn

To enable the flash output use this parameter.

For the mapping of the flash signal to the digital IO check Chapter 6, 'DigitalIO'.

Table 8.3. Parameter properties of FlashOn

Property	Value
Name	FlashOn
Display Name	Flash On
Interface	IEnumeration
Access policy	Read/Write/Change
Visibility	Beginner
Allowed values	On On Off Off
Default value	On

Example 8.3. Usage of FlashOn

```
/* Set */ FlashOn = On;
/* Get */ value_ = FlashOn;
```

8.4. ImageTriggerAsyncHeight

This parameter only has influence in the image trigger mode *ImageTriggerMode Async Trigger Multi Frame* **AsynExternalTriggerMultiframe**. The value is used to define the image height of the frame after the trigger pulse. Whereas parameter *Height* defines the chunk height.

If the value of *ImageTriggerAsyncHeight* is less than *Height*, the frame is not split into multiple frames and will result in a smaller output frame.

Table 8.4. Parameter properties of ImageTriggerAsyncHeight

Property	Value
Name	ImageTriggerAsyncHeight
Display Name	Image Trigger Async Height
Interface	IInteger
Access policy	Read/Write
Visibility	Beginner
Allowed values	Minimum 1 Maximum 16777216 Stepsize 1
Default value	1024
Unit of measure	lines

Example 8.4. Usage of ImageTriggerAsyncHeight

```
/* Set */ ImageTriggerAsyncHeight = 1024;
/* Get */ value_ = ImageTriggerAsyncHeight;
```

8.5. ImageTriggerIsBusy

The image trigger is busy if the current requested frame from the camera has not been completely transferred to the grabber. This parameter can be used to check if the camera can accept a new software trigger pulse.

Table 8.5. Parameter properties of ImageTriggerIsBusy

Property	Value
Name	ImageTriggerIsBusy
Display Name	Image Trigger is Busy
Interface	IEnumeration
Access policy	Read-Only
Visibility	Beginner
Allowed values	Busy Busy NotBusy Not Busy

Example 8.5. Usage of ImageTriggerIsBusy

```
/* Get */ value_ = ImageTriggerIsBusy;
```

8.6. ImageTriggerInput

This category includes parameters to specify and control the image trigger inputs. The input can either be input pins of the frame grabber's trigger connector or trigger pulses generated by software register accesses.

8.6.1. ImageTriggerInputSource

This parameter specifies the signal source, which is used to trigger the image acquisition gate. If a software image trigger has to be used select option **SoftwareTrigger**.

Table 8.6. Parameter properties of ImageTriggerInputSource

Property	Value
Name	ImageTriggerInputSource
Display Name	Image Trigger Input Source
Interface	IEnumeration
Access policy	Read/Write/Change
Visibility	Beginner
Allowed values	GPITriggerSource0 GPI Trigger Source 0 GPITriggerSource1 GPI Trigger Source 1 GPITriggerSource2 GPI Trigger Source 2 GPITriggerSource3 GPI Trigger Source 3 GPITriggerSource4 GPI Trigger Source 4 GPITriggerSource5 GPI Trigger Source 5 GPITriggerSource6 GPI Trigger Source 6 GPITriggerSource7 GPI Trigger Source 7 TriggerInSourceFrontGPI0 Trigger In Source Front GPI 0 TriggerInSourceFrontGPI1 Trigger In Source Front GPI 1 TriggerInSourceFrontGPI2 Trigger In Source Front GPI 2 TriggerInSourceFrontGPI3 Trigger In Source Front GPI 3 SoftwareTrigger Software Trigger
Default value	GPITriggerSource0

Example 8.6. Usage of ImageTriggerInputSource

```
/* Set */ ImageTriggerInputSource = GPITriggerSource0;
/* Get */ value_ = ImageTriggerInputSource;
```

8.6.2. ImageTriggerInputPolarity

The parameter defines the polarity of the external input trigger signal.

Table 8.7. Parameter properties of ImageTriggerInputPolarity

Property	Value
Name	ImageTriggerInputPolarity
Display Name	Image Trigger Input Polarity
Interface	IEnumeration
Access policy	Read/Write/Change
Visibility	Beginner
Allowed values	LowActive Low Active HighActive High Active
Default value	HighActive

Example 8.7. Usage of ImageTriggerInputPolarity

```
/* Set */ ImageTriggerInputPolarity = HighActive;
/* Get */ value_ = ImageTriggerInputPolarity;
```

8.6.3. ImageTriggerGateDelay

With this parameter, a delay of lines can be configured before the activation of the image gate. This delays the start of the image acquisition. The parameter y-offest (as in free run mode) rejects the first lines from the camera. Delay and y-offset seem to have the same effect, however the difference is, that y-offset doesn't affect the image gate, which is relevant while using the gated line trigger mode.

Table 8.8. Parameter properties of ImageTriggerGateDelay

Property	Value
Name	ImageTriggerGateDelay
Display Name	Image Trigger Gate Delay
Interface	IInteger
Access policy	Read/Write
Visibility	Beginner
Allowed values	Minimum 0 Maximum 65535 Stepsize 1
Default value	0
Unit of measure	lines

Example 8.8. Usage of ImageTriggerGateDelay

```
/* Set */ ImageTriggerGateDelay = 0;
/* Get */ value_ = ImageTriggerGateDelay;
```

8.6.4. ImageTriggerDebouncing

This parameter specifies the debouncing time. This is the time for which the input image trigger signal must keep the same value to be detected as such. Fast signal changes within the debounce time will be filtered out.

Table 8.9. Parameter properties of ImageTriggerDebouncing

Property	Value
Name	ImageTriggerDebouncing
Display Name	Image Trigger Debouncing
Interface	IFloat
Access policy	Read/Write/Change
Visibility	Beginner
Allowed values	Minimum 0.0032 Maximum 26.0 Stepsize 0.0032
Default value	0.112
Unit of measure	µs

Example 8.9. Usage of ImageTriggerDebouncing

```
/* Set */ ImageTriggerDebouncing = 0.112;
/* Get */ value_ = ImageTriggerDebouncing;
```

8.6.5. StrobePulseDelay

This parameter specifies the delay of the generated flash signal with respect to an external trigger input. Therefore, it is possible to synchronize the flash to the external trigger input. The delay is set in image line ticks.

Table 8.10. Parameter properties of StrobePulseDelay

Property	Value
Name	StrobePulseDelay
Display Name	Strobe Pulse Delay
Interface	IInteger
Access policy	Read/Write
Visibility	Beginner
Allowed values	Minimum 0 Maximum 65535 Stepsize 1
Default value	0
Unit of measure	lines

Example 8.10. Usage of StrobePulseDelay

```
/* Set */ StrobePulseDelay = 0;
/* Get */ value_ = StrobePulseDelay;
```

8.6.6. Flash

8.6.6.1. FlashPolarity

The polarity of the generated flash signal can be changed with this parameter. For the mapping of the flash signal to the digital outputs check Chapter 6, 'DigitalIO'.

Table 8.11. Parameter properties of FlashPolarity

Property	Value
Name	FlashPolarity
Display Name	Flash Polarity
Interface	IEnumeration
Access policy	Read/Write/Change
Visibility	Beginner
Allowed values	LowActive Low Active HighActive High Active
Default value	HighActive

Example 8.11. Usage of FlashPolarity

```
/* Set */ FlashPolarity = HighActive;
/* Get */ value_ = FlashPolarity;
```

8.6.7. SoftwareTrigger

For the image trigger it is possible to use a software generated trigger signal to replace the external trigger input.

The software trigger control modules allows the to either generate a software trigger pulse or allows to set the state of the software trigger signal to generate a gate i.e. for gated image trigger mode.

To enable the software trigger set parameter *ImageTriggerInputSource* to software trigger.

8.6.7.1. SendSoftwareTrigger

A software trigger pulse can be sent by use of this parameter. Ensure to enable the software trigger by *ImageTriggerInputSource*.

Table 8.12. Parameter properties of SendSoftwareTrigger

Property	Value
Name	SendSoftwareTrigger
Display Name	Send Software Trigger
Interface	ICommand
Access policy	Write/Change
Visibility	Beginner

Example 8.12. Usage of SendSoftwareTrigger

```
/* Set */ SendSoftwareTrigger();
```

8.6.7.2. SetSoftwareTrigger

The software trigger state can be set to zero = inactive = low or one = active = high. Ensure to enable the software trigger by *ImageTriggerInputSource*.

Table 8.13. Parameter properties of SetSoftwareTrigger

Property	Value
Name	SetSoftwareTrigger
Display Name	Set Software Trigger
Interface	IEnumeration
Access policy	Read/Write/Change
Visibility	Beginner
Allowed values	LowActive Low Active HighActive High Active
Default value	

Example 8.13. Usage of SetSoftwareTrigger

```
/* Set */ SetSoftwareTrigger = ;  
/* Get */ value_ = SetSoftwareTrigger;
```

Chapter 9. SignalAnalyzer

The signal analyzer module computes some information on a signal source. These are

- Pulse Count
- Period (current, min, max)
- Difference between two pulse counters

The module is used to detect unexpected behaviors of the trigger system. For example a bouncing encode signal resulting in overtriggering of the camera. Another example is the detection of trigger lost signals or corrupted camera data which can result in extra lines.

Simply select the analyzer source signal and polarity. The measurement values can be obtained using read-only parameters. All measurements can be cleared synchronously.

Note that the module is available only once for the applet. All cameras share the same module. The camera/DMA index in the setParameter and getParameter functions has no influence.

9.1. SignalAnalyzer0Source et al.



Note

This description applies also to the following parameters: SignalAnalyzer1Source

Select the source signal for the trigger analyzer. For further explanation of the available sources see Chapter 6, 'DigitalIO'. In addition, the line/frame start/end pulses can be used as signal sources, too.

Table 9.1. Parameter properties of SignalAnalyzer0Source

Property	Value																																																																
Name	SignalAnalyzer0Source																																																																
Display Name	Signal Analyzer 0 Source																																																																
Interface	IEnumeration																																																																
Access policy	Read/Write/Change																																																																
Visibility	Beginner																																																																
Allowed values	<table border="0"> <tr><td>GND</td><td>GND</td></tr> <tr><td>VCC</td><td>VCC</td></tr> <tr><td>SignalExsync</td><td>Signal Exsync</td></tr> <tr><td>SignalExsync2</td><td>Signal Exsync2</td></tr> <tr><td>SignalFlash</td><td>Signal Flash</td></tr> <tr><td>SignalLineValid</td><td>Signal Line Valid</td></tr> <tr><td>SignalFrameValid</td><td>Signal Frame Valid</td></tr> <tr><td>SignalLineStart</td><td>Signal Line Start</td></tr> <tr><td>SignalLineEnd</td><td>Cam0 Line Transfer End</td></tr> <tr><td>SignalFrameStart</td><td>Signal Frame Start</td></tr> <tr><td>SignalFrameEnd</td><td>Signal Frame End</td></tr> <tr><td>SignalCam1Exsync</td><td>Signal Cam1 Exsync</td></tr> <tr><td>SignalCam1Exsync2</td><td>Signal Cam1 Exsync2</td></tr> <tr><td>SignalCam1Flash</td><td>Signal Cam1 Flash</td></tr> <tr><td>SignalCam1LineValid</td><td>Signal Cam1 Line Valid</td></tr> <tr><td>SignalCam1FrameValid</td><td>Signal Cam1 Frame Valid</td></tr> <tr><td>SignalCam1LineStart</td><td>Signal Cam1 Line Start</td></tr> <tr><td>SignalCam1LineEnd</td><td>Signal Cam1 Line End</td></tr> <tr><td>SignalCam1FrameStart</td><td>Signal Cam1 Frame Start</td></tr> <tr><td>SignalCam1FrameEnd</td><td>Signal Cam1 Frame End</td></tr> <tr><td>SignalGPI0</td><td>Signal GPI 0</td></tr> <tr><td>SignalGPI1</td><td>Signal GPI 1</td></tr> <tr><td>SignalGPI2</td><td>Signal GPI 2</td></tr> <tr><td>SignalGPI3</td><td>Signal GPI 3</td></tr> <tr><td>SignalGPI4</td><td>Signal GPI 4</td></tr> <tr><td>SignalGPI5</td><td>Signal GPI 5</td></tr> <tr><td>SignalGPI6</td><td>Signal GPI 6</td></tr> <tr><td>SignalGPI7</td><td>Signal GPI 7</td></tr> <tr><td>SignalFrontGPI0</td><td>Signal Front GPI 0</td></tr> <tr><td>SignalFrontGPI1</td><td>Signal Front GPI 1</td></tr> <tr><td>SignalFrontGPI2</td><td>Signal Front GPI 2</td></tr> <tr><td>SignalFrontGPI3</td><td>Signal Front GPI 3</td></tr> </table>	GND	GND	VCC	VCC	SignalExsync	Signal Exsync	SignalExsync2	Signal Exsync2	SignalFlash	Signal Flash	SignalLineValid	Signal Line Valid	SignalFrameValid	Signal Frame Valid	SignalLineStart	Signal Line Start	SignalLineEnd	Cam0 Line Transfer End	SignalFrameStart	Signal Frame Start	SignalFrameEnd	Signal Frame End	SignalCam1Exsync	Signal Cam1 Exsync	SignalCam1Exsync2	Signal Cam1 Exsync2	SignalCam1Flash	Signal Cam1 Flash	SignalCam1LineValid	Signal Cam1 Line Valid	SignalCam1FrameValid	Signal Cam1 Frame Valid	SignalCam1LineStart	Signal Cam1 Line Start	SignalCam1LineEnd	Signal Cam1 Line End	SignalCam1FrameStart	Signal Cam1 Frame Start	SignalCam1FrameEnd	Signal Cam1 Frame End	SignalGPI0	Signal GPI 0	SignalGPI1	Signal GPI 1	SignalGPI2	Signal GPI 2	SignalGPI3	Signal GPI 3	SignalGPI4	Signal GPI 4	SignalGPI5	Signal GPI 5	SignalGPI6	Signal GPI 6	SignalGPI7	Signal GPI 7	SignalFrontGPI0	Signal Front GPI 0	SignalFrontGPI1	Signal Front GPI 1	SignalFrontGPI2	Signal Front GPI 2	SignalFrontGPI3	Signal Front GPI 3
GND	GND																																																																
VCC	VCC																																																																
SignalExsync	Signal Exsync																																																																
SignalExsync2	Signal Exsync2																																																																
SignalFlash	Signal Flash																																																																
SignalLineValid	Signal Line Valid																																																																
SignalFrameValid	Signal Frame Valid																																																																
SignalLineStart	Signal Line Start																																																																
SignalLineEnd	Cam0 Line Transfer End																																																																
SignalFrameStart	Signal Frame Start																																																																
SignalFrameEnd	Signal Frame End																																																																
SignalCam1Exsync	Signal Cam1 Exsync																																																																
SignalCam1Exsync2	Signal Cam1 Exsync2																																																																
SignalCam1Flash	Signal Cam1 Flash																																																																
SignalCam1LineValid	Signal Cam1 Line Valid																																																																
SignalCam1FrameValid	Signal Cam1 Frame Valid																																																																
SignalCam1LineStart	Signal Cam1 Line Start																																																																
SignalCam1LineEnd	Signal Cam1 Line End																																																																
SignalCam1FrameStart	Signal Cam1 Frame Start																																																																
SignalCam1FrameEnd	Signal Cam1 Frame End																																																																
SignalGPI0	Signal GPI 0																																																																
SignalGPI1	Signal GPI 1																																																																
SignalGPI2	Signal GPI 2																																																																
SignalGPI3	Signal GPI 3																																																																
SignalGPI4	Signal GPI 4																																																																
SignalGPI5	Signal GPI 5																																																																
SignalGPI6	Signal GPI 6																																																																
SignalGPI7	Signal GPI 7																																																																
SignalFrontGPI0	Signal Front GPI 0																																																																
SignalFrontGPI1	Signal Front GPI 1																																																																
SignalFrontGPI2	Signal Front GPI 2																																																																
SignalFrontGPI3	Signal Front GPI 3																																																																
Default value	SignalExsync																																																																

Example 9.1. Usage of SignalAnalyzer0Source

```
/* Set */ SignalAnalyzer0Source = SignalExsync;
/* Get */ value_ = SignalAnalyzer0Source;
```

9.2. SignalAnalyzer0Polarity et al.



Note

This description applies also to the following parameters: SignalAnalyzer1Polarity

Select the polarity for the signal analyzer of the selected source. With this parameter you can invert the signal. The signal analyzer module will only measure on rising edges.

Table 9.2. Parameter properties of SignalAnalyzer0Polarity

Property	Value
Name	SignalAnalyzer0Polarity
Display Name	Signal Analyzer 0 Polarity
Interface	IEnumeration
Access policy	Read/Write/Change
Visibility	Beginner
Allowed values	LowActive Low Active HighActive High Active
Default value	HighActive

Example 9.2. Usage of SignalAnalyzer0Polarity

```
/* Set */ SignalAnalyzer0Polarity = HighActive;
/* Get */ value_ = SignalAnalyzer0Polarity;
```

9.3. SignalAnalyzer0CurrentPeriod et al.



Note

This description applies also to the following parameters: SignalAnalyzer1CurrentPeriod

This read-only parameter returns the last measured period of the selected signal source. Keep in mind that the module requires two rising edges to obtain a measurement result. Selecting a new source or changing the acquisition states can result in very long periods.

Table 9.3. Parameter properties of SignalAnalyzer0CurrentPeriod

Property	Value
Name	SignalAnalyzer0CurrentPeriod
Display Name	Signal Analyzer 0 Current Period
Interface	IFloat
Access policy	Read-Only
Visibility	Beginner
Allowed values	Minimum 0.0032 Maximum 1.3743895344E7 Stepsize 0.0032
Unit of measure	µs

Example 9.3. Usage of SignalAnalyzer0CurrentPeriod

```
/* Get */ value_ = SignalAnalyzer0CurrentPeriod;
```

9.4. SignalAnalyzer0MaxPeriod et al.



Note

This description applies also to the following parameters: SignalAnalyzer1MaxPeriod

This read-only parameter returns the maximum measured period after the last reset. Keep in mind that selecting a new source or changing the acquisition states can result in very long periods.

Table 9.4. Parameter properties of SignalAnalyzer0MaxPeriod

Property	Value
Name	SignalAnalyzer0MaxPeriod
Display Name	Signal Analyzer 0 Max Period
Interface	IFloat
Access policy	Read-Only
Visibility	Beginner
Allowed values	Minimum 0.0032 Maximum 1.3743895344E7 Stepsize 0.0032
Unit of measure	µs

Example 9.4. Usage of SignalAnalyzer0MaxPeriod

```
/* Get */ value_ = SignalAnalyzer0MaxPeriod;
```

9.5. SignalAnalyzer0MinPeriod et al.



Note

This description applies also to the following parameters: SignalAnalyzer1MinPeriod

This read-only parameter returns the minimum measured period after the last reset.

Table 9.5. Parameter properties of SignalAnalyzer0MinPeriod

Property	Value
Name	SignalAnalyzer0MinPeriod
Display Name	Signal Analyzer 0 Min Period
Interface	IFloat
Access policy	Read-Only
Visibility	Beginner
Allowed values	Minimum 0.0032 Maximum 1.3743895344E7 Stepsize 0.0032
Unit of measure	µs

Example 9.5. Usage of SignalAnalyzer0MinPeriod

```
/* Get */ value_ = SignalAnalyzer0MinPeriod;
```

9.6. SignalAnalyzer0PulseCount et al.



Note

This description applies also to the following parameters: SignalAnalyzer1PulseCount

Returns the counter value of the selected source. For each rising edge the counter is increased. This, after the first pulse, the counter value will be one. On counter overflow, it will start from 0 again.

Table 9.6. Parameter properties of SignalAnalyzer0PulseCount

Property	Value
Name	SignalAnalyzer0PulseCount
Display Name	Signal Analyzer 0 Pulse Count
Interface	IInteger
Access policy	Read-Only
Visibility	Beginner
Allowed values	Minimum 0 Maximum 4294967295 Stepsize 1
Unit of measure	pulses

Example 9.6. Usage of SignalAnalyzer0PulseCount

```
/* Get */ value_ = SignalAnalyzer0PulseCount;
```

9.7. SignalAnalyzerPulseCountDifference

Use this read only parameter to check the difference of the signal analyzer 0 and 1 pulse counter values (Analyzer 0 - Analyzer 1 value). This can be used to check for trigger lost signals if analyzer 0 will count the exsync pulses and analyzer 1 the returned camera lines. In this case the difference is between 0 and 1 for single line cameras with no extra delay. If the difference exceeds 1, the camera did not return a line for all trigger pulses i.e. a trigger is lost or ignored due to overtriggering. If the difference is less than 0 an additional camera line was generated and received by the frame grabber. The reason for this can be a noisy trigger cable which added extra spikes or a corrupted data transfer which split the data into several parts.

Table 9.7. Parameter properties of SignalAnalyzerPulseCountDifference

Property	Value
Name	SignalAnalyzerPulseCountDifference
Display Name	Signal Analyzer Pulse Count Difference
Interface	IInteger
Access policy	Read-Only
Visibility	Beginner
Allowed values	Minimum -4294967296 Maximum 4294967295 Stepsize 1
Unit of measure	pulses

Example 9.7. Usage of SignalAnalyzerPulseCountDifference

```
/* Get */ value_ = SignalAnalyzerPulseCountDifference;
```

9.8. SignalAnalyzerClear

To clear all signal analyzer measurement results and counters use this parameter. All counters will be reset synchronously and are ready to restart immediately.

Table 9.8. Parameter properties of SignalAnalyzerClear

Property	Value
Name	SignalAnalyzerClear
Display Name	Signal Analyzer Clear
Interface	ICommand
Access policy	Write/Change
Visibility	Beginner

Example 9.8. Usage of SignalAnalyzerClear

```
/* Set */ SignalAnalyzerClear();
```

Chapter 10. BufferStatus

The applet processes image data as fast as possible. Any image data sent by the camera is immediately processed and sent to the PC. The latency is minimal. In general, only one concurrent image line is stored and processed in the frame grabber. However, the transfer bandwidth to the PC via DMA channel can vary caused by interrupts, other hardware and the current CPU load. Furthermore, if operated in **selective mode**, it is possible to queue buffer slower than the camera offers new images and therefore generate an overflow condition on the frame grabber. Also, the camera frame rate can vary due to an fluctuating trigger. For these cases, the applet is equipped with a memory to buffer the input frames. The fill level of the buffer can be obtained by reading from parameter *FillLevel*.

In normal operation conditions the buffer will always remain almost empty. For fluctuating camera bandwidths or for short and fast acquisitions, the buffer can easily fill up quickly. Of course, the input bandwidth must not exceed the maximum bandwidth of the applet. Check Section 1.2, 'Bandwidth' for more information.

If the buffer's fill level reaches 100%, the applet is in overflow condition, as no more data can be buffered and camera data will be discarded. This can result in two different behaviors:

- Corrupted Frames:

The transfer of a current frame is interrupted by an overflow. This means, the first pixels or lines of the frame were transferred into the buffer, but not the full frame. The output of the applet i.e. the DMA transfer will be shorter. The output image will not have it's full height. These images will be marked incomplete. Check the Basler GenTL documentation to learn on how to identify incompleted buffers (<https://www.baslerweb.com/en/sales-support/downloads/document-downloads/cxp-gentl-producer-feature-documentation/>).

- Lost Frames:

A full camera frame was discarded due to a full buffer memory. No DMA transfer will exist for the discarded frame. This means the number of applet output images can differ from the number of applet input images.

The buffer overflow threshold *OverflowOnThreshold* and *OverflowSyncOnThreshold* default ensures that under normal conditions frames can be completed or will be fully dropped so that corrupted frames are avoided

A way to detect the overflows is to read parameter *Overflow* or check for event *Overflow*. Reading from the parameter will provide information about an overflow condition. As soon as the parameter is read, it will reset. Using the parameter an overflow condition can be detect, but it is not possible to obtain the exact image number and the moment. For this, the overflow event can be used.

10.1. FillLevel

The fill-level of the frame grabber buffers used in this applet can be read-out by use of this parameter. The value allows to check if the mean input bandwidth of the camera is to high to be processed with the applet.

Table 10.1. Parameter properties of FillLevel

Property	Value
Name	FillLevel
Display Name	Fill Level
Interface	IInteger
Access policy	Read-Only
Visibility	Beginner
Allowed values	Minimum 0 Maximum 100 Stepsize 1
Unit of measure	%

Example 10.1. Usage of FillLevel

```
/* Get */ value_ = FillLevel;
```

10.2. Overflow

If the applet runs into overflow, a value "1" can be read by the use of this parameter. Note that an overflow results in loss of images. To avoid overflows reduce the mean input bandwidth.

The parameter is reset at each readout cycle. The program microDisplayX will continuously poll the value, thus the occurrence of an overflow might not be visible in microDisplayX.

A more effective and robust way is to detect overflows is the use of the event system.

Table 10.2. Parameter properties of Overflow

Property	Value
Name	Overflow
Display Name	Buffer overflow
Interface	IInteger
Access policy	Read-Only
Visibility	Beginner
Allowed values	Minimum 0 Maximum 1 Stepsize 1

Example 10.2. Usage of Overflow

```
/* Get */ value_ = Overflow;
```

10.3. OverflowOffThreshold

The Overflow state will be deactivated once the buffer Fillevel (*FillLevel*) will fall below this value. As long as the applet remains in overflow state all images arriving will be discarded. This will result in Overflow events with a set "lost" flag.

Table 10.3. Parameter properties of OverflowOffThreshold

Property	Value
Name	OverflowOffThreshold
Display Name	Overflow Off Threshold
Interface	IFloat
Access policy	Read/Write/Change
Visibility	Beginner
Allowed values	Minimum 0.0 Maximum 100.0 Stepsize 0.5
Default value	50.0

Example 10.3. Usage of OverflowOffThreshold

```
/* Set */ OverflowOffThreshold = 50.0;
/* Get */ value_ = OverflowOffThreshold;
```

10.4. OverflowOnThreshold

The applet will enter Overflow state once the buffer Filllevel exceeds this filllevel (*FillLevel*). If the overflow state is active images will be stopped immediately. This may lead to an incomplete frame. Incomplete frames are marked incomplete in the image Tag and an overflow event can be generated.

Table 10.4. Parameter properties of OverflowOnThreshold

Property	Value
Name	OverflowOnThreshold
Display Name	Overflow On Threshold
Interface	IFloat
Access policy	Read/Write/Change
Visibility	Beginner
Allowed values	Minimum 0.0 Maximum 100.0 Stepsize 0.5
Default value	99.5

Example 10.4. Usage of OverflowOnThreshold

```
/* Set */ OverflowOnThreshold = 99.5;
/* Get */ value_ = OverflowOnThreshold;
```

10.5. OverflowSyncOnThreshold

The applet will enter Overflow state once the buffer filllevel (*FillLevel*) exceeds this filllevel and the currently arriving frame is stored to the buffer. If the applet remains in overflow state frames might be dropped. If the buffer falls below this filllevel frames are accepted again. There is no hysteresis for this threshold.

Table 10.5. Parameter properties of OverflowSyncOnThreshold

Property	Value
Name	OverflowSyncOnThreshold
Display Name	Overflow Sync On Threshold
Interface	IFloat
Access policy	Read/Write/Change
Visibility	Beginner
Allowed values	Minimum 0.0 Maximum 100.0 Stepsize 0.5
Default value	80.0

Example 10.5. Usage of OverflowSyncOnThreshold

```
/* Set */ OverflowSyncOnThreshold = 80.0;
/* Get */ value_ = OverflowSyncOnThreshold;
```

10.6. OverflowEventSelect

The *Overflow* Event. Allows to generate events if one of the following conditions is meet.

Table 10.6. Event select for *Overflow*

Value	Description
Incomplete	Each incomplete frame will generate an Event containing the information that the frame is incomplete and the frameID
Lost	Each lost frame will generate an Event containing the information that the frame is lost and the frameID
IncompleteLost	Each lost or incomplete frame will generate an Event containing the information that the frame is lost/incomplete and the frameID
OK	Each correct frame will generate an Event containing the information that the frame is transferred correct and the frameID of the frame
IncompleteOK	Each incomplete or correct frame will generate an Event containing the information that the frame is correct or incomplete and the frameID
LostOK	Each lost or correct frame will generate an Event containing the information that the frame is correct or lost and the frameID
All	Each frame will generate an Event containing the status (lost, incomplete or correct) of the frame and the frameID

Table 10.7. Parameter properties of *OverflowEventSelect*

Property	Value														
Name	OverflowEventSelect														
Display Name	Overflow Event Select														
Interface	IEnumeration														
Access policy	Read/Write/Change														
Visibility	Beginner														
Allowed values	<table border="0"> <tr> <td>Incomplete</td> <td>Incomplete</td> </tr> <tr> <td>Lost</td> <td>Lost</td> </tr> <tr> <td>IncompleteLost</td> <td>Incomplete Lost</td> </tr> <tr> <td>OK</td> <td>OK</td> </tr> <tr> <td>IncompleteOK</td> <td>Incomplete OK</td> </tr> <tr> <td>LostOK</td> <td>Lost OK</td> </tr> <tr> <td>All</td> <td>All</td> </tr> </table>	Incomplete	Incomplete	Lost	Lost	IncompleteLost	Incomplete Lost	OK	OK	IncompleteOK	Incomplete OK	LostOK	Lost OK	All	All
Incomplete	Incomplete														
Lost	Lost														
IncompleteLost	Incomplete Lost														
OK	OK														
IncompleteOK	Incomplete OK														
LostOK	Lost OK														
All	All														
Default value	IncompleteLost														

Example 10.6. Usage of *OverflowEventSelect*

```
/* Set */ OverflowEventSelect = IncompleteLost;
/* Get */ value_ = OverflowEventSelect;
```

10.7. OverflowEvents

In programming or runtime environments, a callback function is a piece of executable code that is passed as an argument, which is expected to call back (execute) exactly that time an event is triggered. This applet can generate some software callback events based on the memory overflow condition as explained in the following section. These events are not related to a special camera functionality. Other event sources are described in additional sections of this document.

The Basler Framegrabber SDK and pylon SDK via GenTL enables an application to get these event notifications about certain state changes at the data flow from camera to RAM and the image and trigger processing as well. Please consult the Basler Framegrabber SDK, pylon SDK or GenTL documentation for more details concerning the implementation of this functionality.

10.7.1. Overflow

Overflow events are generated for each truncated, lost or complete frame. The selection can be done using *OverflowEventSelect*. The overflow event contains data, namely the type of overflow, the image number and the timestamp. The following figure illustrates the event data. Data is contained in a 64-bit data packet. The first 16 bits contain the frame-ID from the camera. Bits 32 to 47 provide an overflow mask.

Figure 10.1. Illustration of Overflow Data Packet

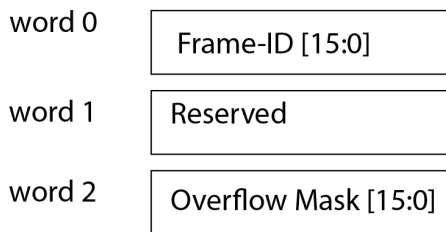

Overflow Mask [15:0]

0	Frame is truncated
1	Frame is lost
2	Reserved
3	Frame is complete
4	End of sequence
5	Reserved
6	
7	
8	
9	
10	
11	
12	
13	
14	
15	

Note that the frame-ID is taken from the camera stream. See Section 1.5, 'Frame ID' for more information. The frame-ID is a 16-bit value. If its maximum is reached, the frame-ID starts at zero again. If the **frame truncated** flag is set, the frame with the frame-ID in the event is truncated i.e. it doesn't have its full length but is still transferred via DMA channel. If the **frame lost** flag is set, the frame with the frame-ID in the event was fully discarded. No DMA transfer exists for this frame. The **truncated frame** flag and the **frame lost** flag never occur for the same event.

Table 10.8. Event parameters of Overflow

Name	Interface	Description
EventOverflowFrameID	Integer	Camera frame-ID for area scan applets or grabber frame-ID for line scan applets.
EventOverflowsTruncated	Boolean	Frame is truncated.
EventOverflowsLost	Boolean	Frame is lost.
EventOverflowsComplete	Boolean	Frame is complete.
EventOverflowsEndOfSequence	Boolean	Marks the end of a sequence.

Chapter 11. ImageSelector

The Image Selector allows the user to cut out a period of p images from the image stream and select a particular image n from it.

The following example will explain the settings of p and n which represent the frame grabber parameters *ImageSelectPeriod* and *ImageSelect*. Suppose two frame grabbers being connected to a camera signal multiplexer, providing all camera images to both devices. Grabber 0 is required to process all even frames, while grabber 1 is required to process all odd frames. The settings will then be:

1. Grabber 0:
 - *ImageSelectPeriod* = 2
 - ImageSelect* = 0
2. Grabber 1:
 - *ImageSelectPeriod* = 2
 - ImageSelect* = 1

Ensure that both grabbers are used synchronously. This is possible with a triggered camera. To do so, initialize and configure both frame grabbers. Configure the camera for external trigger and the trigger system of master grabber which is directly connected to the camera.

11.1. ImageSelectPeriod

This parameter specifies the period length p . The parameter can be changed at any time. However, changing during acquisition can result in an asynchronous switching which will result in the loss of a synchronous grabbing. It is recommended to change the parameter only when the acquisition is stopped.

The parameter's value has to be greater than *ImageSelect*.

Table 11.1. Parameter properties of ImageSelectPeriod

Property	Value
Name	ImageSelectPeriod
Display Name	Image Select Period
Interface	IInteger
Access policy	Read/Write/Change
Visibility	Beginner
Allowed values	Minimum 1 Maximum 256 Stepsize 1
Default value	1
Unit of measure	image

Example 11.1. Usage of ImageSelectPeriod

```
/* Set */ ImageSelectPeriod = 1;  
/* Get */ value_ = ImageSelectPeriod;
```

11.2. ImageSelect

The parameter *ImageSelect* specifies a particular image from the image set defined by *ImageSelectPeriod*. This parameter can be changed at any time. However, changing during acquisition can result in an asynchronous switching which will result in the loss of a synchronous grabbing. It is recommended to change the parameter only when the acquisition is stopped.

The parameter's value has to be less than *ImageSelectPeriod*.

Table 11.2. Parameter properties of ImageSelect

Property	Value
Name	ImageSelect
Display Name	Image Select
Interface	IInteger
Access policy	Read/Write/Change
Visibility	Beginner
Allowed values	Minimum 0 Maximum 255 Stepsize 1
Default value	0
Unit of measure	image

Example 11.2. Usage of ImageSelect

```
/* Set */ ImageSelect = 0;
/* Get */ value_ = ImageSelect;
```

Chapter 12. WhiteBalance

The applet enables a spectral adaptation of the image to the lighting situation of the application. The color values for the red, green and blue components can be individually enhanced or reduced by a scaling factor to adjust the spectral sensibility of the camera sensor.

12.1. ScalingFactorGreen

Table 12.1. Parameter properties of ScalingFactorGreen

Property	Value
Name	ScalingFactorGreen
Display Name	Scaling Factor Green
Interface	IFloat
Access policy	Read/Write/Change
Visibility	Beginner
Allowed values	Minimum 0.0 Maximum 3.9990234375 Stepsize 9.765625E-4
Default value	1.0

Example 12.1. Usage of ScalingFactorGreen

```
/* Set */ ScalingFactorGreen = 1.0;  
/* Get */ value_ = ScalingFactorGreen;
```

12.2. ScalingFactorRed

Table 12.2. Parameter properties of ScalingFactorRed

Property	Value
Name	ScalingFactorRed
Display Name	Scaling Factor Red
Interface	IFloat
Access policy	Read/Write/Change
Visibility	Beginner
Allowed values	Minimum 0.0 Maximum 3.9990234375 Stepsize 9.765625E-4
Default value	1.0

Example 12.2. Usage of ScalingFactorRed

```
/* Set */ ScalingFactorRed = 1.0;  
/* Get */ value_ = ScalingFactorRed;
```

12.3. ScalingFactorBlue

Table 12.3. Parameter properties of ScalingFactorBlue

Property	Value
Name	ScalingFactorBlue
Display Name	Scaling Factor Blue
Interface	IFloat
Access policy	Read/Write/Change
Visibility	Beginner
Allowed values	Minimum 0.0 Maximum 3.9990234375 Stepsize 9.765625E-4
Default value	1.0

Example 12.3. Usage of ScalingFactorBlue

```
/* Set */ ScalingFactorBlue = 1.0;  
/* Get */ value_ = ScalingFactorBlue;
```

Chapter 13. ColorConverter

The color converter module is used to convert the input pixel format to an output pixel format. The conversion is performed post to the Bayer de-mosicing and just before the lookup table.

This applet can perform the following conversions.

Table 13.1. Color Conversion

Input Format	Mono	RGB	Bayer	YCbCr
Output Format				
Mono	yes	yes	yes	N/A
RGB	yes	yes	yes	N/A
Bayer	N/A	N/A	yes	N/A
YCbCr	N/A	N/A	N/A	yes

By setting the input and output format the conversion is automatically applied if a conversion is possible. Otherwise the applet will output unchanged values. See *PixelFormat* and *Format*.

Chapter 14. LookupTable

This Acquisition Applet includes a full resolution lookup table (LUT) for each of the three color components. Settings are applied to the acquired images just before transferring them to the host PC. Thus, it is the last pre-processing step on the frame grabber.

A lookup table includes one entry for every allowed input pixel value. The pixel value will be replaced by the value of the lookup table element. In other words, a new value is assigned to each pixel value. This can be used for image quality enhancements such as an added offset, a gain factor or gamma correction which can be performed by use of the processing module of this applet in a convenient way (see Module Chapter 15, 'Processing'). The lookup table can also be loaded with custom values. Application areas are custom image enhancements or correct pixel classifications.

This applet is processing data with an internal resolution of 16 bits. But the lookup table has 14 input bits i.e. pixel values can be in the range [0, 16383]. For each of these 16383 elements, a table entry exists containing a new output value. The new values are in the range from 0 to 65536. All color components are treated separately. Since this applet uses 16 bit internally, consider that all values need to represent this value range. This LUT is applied to all pixel values before *Format* is applied. The input values for the LUT are aligned to the most significant bit (MSB).

In the following the parameters to use the lookup table are explained. Parameter *LutType* is important to be set correctly as it defines the lookup table operation mode.

14.1. LutEnable

It is possible to disable the functionality of this lookup table. The internal processor enables a convenient way to improve the image quality using parameters such as offset, gain and gamma. By disabling the lookup table the processing functions are not available anymore. See category Chapter 15, 'Processing' for a more detailed documentation concerning this. Set this parameter to **On** to use the look up table. By default it is set to **Off** disabling the lookup table functionality itself and the related processing functions.

Table 14.1. Parameter properties of LutEnable

Property	Value
Name	LutEnable
Display Name	Enabled
Interface	IEnumeration
Access policy	Read/Write/Change
Visibility	Beginner
Allowed values	On On Off Off
Default value	Off

Example 14.1. Usage of LutEnable

```
/* Set */ LutEnable = Off;  
/* Get */ value_ = LutEnable;
```

14.2. LutType

There exist two basic possibilities to use and configure the lookup table. One possibility is to use the internal processor which allows a convenient way to improve the image quality using parameters such as offset, gain

and gamma. Check category Chapter 15, 'Processing' for more detailed documentation. Set this parameter to **LutTypeProcessing** to use the processor.

The second possibility to use the lookup table is to load a file containing custom values to the lookup table. Set the parameter to **UserFile** to enable the possibility to load a custom file with lookup table entries.

Beside these two possibilities it is always possible to directly write to the lookup table entries using the field parameters *LutValueRed*, *LutValueGreen* and *LutValueBlue*. The use of these parameters will overwrite the settings made with the processor or the custom input file. Vice versa, changing a processing parameter or loading a custom lookup table file, will overwrite the settings made by the field parameters.

Table 14.2. Parameter properties of LutType

Property	Value
Name	LutType
Display Name	Type
Interface	IEnumeration
Access policy	Read/Write/Change
Visibility	Beginner
Allowed values	LutTypeProcessing Processor UserFile User File
Default value	LutTypeProcessing

Example 14.2. Usage of LutType

```
/* Set */ LutType = LutTypeProcessing;
/* Get */ value_ = LutType;
```

14.3. LutValue

Table 14.3. Parameter properties of LutValue

Property	Value
Name	LutValue
Display Name	LUT Values
Interface	IInteger (Field)
Field Size	16384
Access policy	Read/Write/Change
Visibility	Beginner
Default value	0

Example 14.3. Usage of LutValue

```
/* Set */ for (i = 0; i < 16384; ++i)
{
    LutValueSelector = i;
    LutValue = 0;
}
/* Get */ for (i = 0; i < 16384; ++i)
{
    LutValueSelector = i;
    value_ = LutValue;
}
```

14.4. LutValueRed

Table 14.4. Parameter properties of LutValueRed

Property	Value
Name	LutValueRed
Display Name	Red LUT Values
Interface	IInteger (Field)
Field Size	16384
Access policy	Read/Write/Change
Visibility	Beginner
Default value	0

Example 14.4. Usage of LutValueRed

```

/* Set */ for (i = 0; i < 16384; ++i)
{
    LutValueRedSelector = i;
    LutValueRed = 0;
}
/* Get */ for (i = 0; i < 16384; ++i)
{
    LutValueRedSelector = i;
    value_ = LutValueRed;
}

```

14.5. LutValueGreen

Table 14.5. Parameter properties of LutValueGreen

Property	Value
Name	LutValueGreen
Display Name	Green LUT Values
Interface	IInteger (Field)
Field Size	16384
Access policy	Read/Write/Change
Visibility	Beginner
Default value	0

Example 14.5. Usage of LutValueGreen

```

/* Set */ for (i = 0; i < 16384; ++i)
{
    LutValueGreenSelector = i;
    LutValueGreen = 0;
}
/* Get */ for (i = 0; i < 16384; ++i)
{
    LutValueGreenSelector = i;
    value_ = LutValueGreen;
}

```

14.6. LutValueBlue

Table 14.6. Parameter properties of LutValueBlue

Property	Value
Name	LutValueBlue
Display Name	Blue LUT Values
Interface	IInteger (Field)
Field Size	16384
Access policy	Read/Write/Change
Visibility	Beginner
Default value	0

Example 14.6. Usage of LutValueBlue

```

/* Set */ for (i = 0; i < 16384; ++i)
{
    LutValueBlueSelector = i;
    LutValueBlue = 0;
}
/* Get */ for (i = 0; i < 16384; ++i)
{
    LutValueBlueSelector = i;
    value_ = LutValueBlue;
}

```

14.7. LutCustomFile

If parameter *LutType* is set to **UserFile**, the according path and filename to the file containing the custom lookup table entries can be set here. If the file is valid, the file values will be loaded to the lookup table. If the file is invalid, the call to this parameter will return an error.

A convenient way of getting a draft file, is to save the current lookup table settings to file using parameter *LutSaveFile*.

Please make sure to activate the Type of LUT *LutType* to "UserFile"/**UserFile** in order to make the changes and file names taking effect.

This section describes the file formats which are in use to fill the so called look-up tables (LUT). The purpose of a LUT is a transformation of pixel values from a input (source) image to the pixel values of an output image. This transformation is done by a kind of table, which contains the assignment between these pixel values (input pixel values - output pixel values). Basically the LUT is defined for gray format and color formats as well. When defining a LUT for color formats, the definition of tables has to be done for each color component. The LUT file format consists of 2 parts:

- Header section containing control and description information.
- Main section containing the assignment table for transforming pixel values form a source (input) image to a destination (output) image.

The following example shows how a grey scale lookup table description could look like:

```

# Lut data file v1.1
id=3;
nrOfElements=4096;
format=0;
number=0;
0,0;
1,1;
2,2;
3,3;

```

```
4,4;
5,5;
6,6;
...
4095,4095;
```

General Properties:

- File format extension should be ".lut"
- LUT file format is an ASCII file format consisting of multiple lines of data.
- Lines are defined by a line separator a <CR> <LF> line feed (0x3D 0x0D 0x0A).
- Lines consist of key / value pairs. Key and value are separated by "=". The value has to be followed by a semicolon ; (0x3B)
- Formats consist of header data, containing control information and the assignment table for a specific color component (gray / red, green, blue).
- Basically the LUT file color format follows the same rules as the gray image format. In addition, due to the fact, that each color component can has its own transformation, the definitions are repeated for each color component.

The following example shows how a color scale lookup table description could look like:

```
# Lut data file v1.1
[red]
id=0;
nrOfElements=256;
format=0;
number=0;
0,0;
1,1;
..
255,255;
[green]
id=1;
nrOfElements=256;
format=0;
number=0;
0,0;
1,1;
..
255,255;
[blue]
id=2;
nrOfElements=256;
format=0;
number=0;
0,0;
1,1;
..
255,255;
```

A more detailed explanation of the lookup table file format can be found in the Basler Framegrabber API manual.

Table 14.7. Parameter properties of LutCustomFile

Property	Value
Name	LutCustomFile
Display Name	Load File
Interface	IString
Access policy	Read/Write/Change
Visibility	Beginner
Default value	""

Example 14.7. Usage of LutCustomFile

14.8. LutSaveFile

To save the current lookup table configuration to a file, write the according output filename to this parameter. Keep in mind that you need to have full write access to the specified path.

Writing the current lookup table settings to a file is also a convenient way to exploit the settings made by the processor. Moreover, you will get a draft version of the lookup table file format. The values in the output file can directly be used to be loaded to the lookup table again using parameter *LutCustomFile*.

Table 14.8. Parameter properties of LutSaveFile

Property	Value
Name	LutSaveFile
Display Name	Save File
Interface	IString
Access policy	Read/Write/Change
Visibility	Beginner
Default value	""

Example 14.8. Usage of LutSaveFile

14.9. AppletProperties

In the following, some properties of the lookup table implementation are listed.

14.9.1. LutImplementationType

In this applet, a full lookup table is implemented and can be setup in a custom way. By default a linear representation is performed.

Table 14.9. Parameter properties of LutImplementationType

Property	Value
Name	LutImplementationType
Display Name	LUT Implementation Type
Interface	IEnumeration
Access policy	Read-Only
Visibility	Beginner
Allowed values	FullLUT Full LUT KneeLUT Knee LUT

Example 14.9. Usage of LutImplementationType

```
/* Get */ value_ = LutImplementationType;
```

14.9.2. LutInputPixelBitDepth

This applet is using 14 lookup table input bits.

Table 14.10. Parameter properties of LutInputPixelBitDepth

Property	Value
Name	LutInputPixelBitDepth
Display Name	LUT Input Pixel Bit Depth
Interface	IInteger
Access policy	Read-Only
Visibility	Beginner
Allowed values	Minimum 0 Maximum 16 Stepsize 1
Unit of measure	bit

Example 14.10. Usage of LutInputPixelBitDepth

```
/* Get */ value_ = LutInputPixelBitDepth;
```

14.9.3. LutOutputPixelBitDepth

This applet is using 16 lookup table output bits.

Table 14.11. Parameter properties of LutOutputPixelBitDepth

Property	Value
Name	LutOutputPixelBitDepth
Display Name	LUT Output Pixel Bit Depth
Interface	IInteger
Access policy	Read-Only
Visibility	Beginner
Allowed values	Minimum 0 Maximum 16 Stepsize 1
Unit of measure	bit

Example 14.11. Usage of LutOutputPixelBitDepth

```
/* Get */ value_ = LutOutputPixelBitDepth;
```

Chapter 15. Processing

A convenient way to improve the image quality are the processing parameters. Using these parameters an offset, gain and gamma correction can be performed. Moreover, the image can be inverted.



Processor Activation

The processing parameters use the lookup table for determination of the correction values. For activation of the processing parameters, set *LutType* of category lookup table to **LutTypeProcessing**. Otherwise, parameter changes will have no effect.

All transformations apply in the following order:

1. Offset Correction, range [-1.0, +1.0], identity = 0
2. Gain Correction, range [0, 2¹⁴], identity = 1.0
3. Gamma Correction, range]0, inf], identity = 1.0
4. Invert, identity = 'off'

In this applet, a full lookup table with m = 14 input bits and n = 16 outputs bits is used to perform the corrections. Values are determined by

Equation 15.1. LUT Processor without Inversion

$$Output(x) = \left[\left[gain * \left(\frac{x}{2^{14} - 1} + offset \right) \right]^{\frac{1}{gamma}} \right] * (2^{16} - 1).$$

If the inversion is used, output values are determined by

Equation 15.2. LUT Processor with Inversion

$$Output(x) = 2^{16} - 1 - \left[\left[gain * \left(\frac{x}{2^{14} - 1} + offset \right) \right]^{\frac{1}{gamma}} \right] * (2^{16} - 1),$$

where x represents the input pixel value i.e. is in the range from 0 to 2¹⁴ - 1. If the determined output value is less than 0, it will be set to 0. If the determined output value is greater than 2¹⁶ - 1 it is set to 2¹⁶ - 1.

This applet processes each color component separately using the same processing parameters for each component.

If no parameters are changed, i.e. they are set to identity, the output values will be equal to the input values as shown in the figure below. In the following, you will find detailed explanations for all processing parameters.

Figure 15.1. Lookup Table Processing: Identity

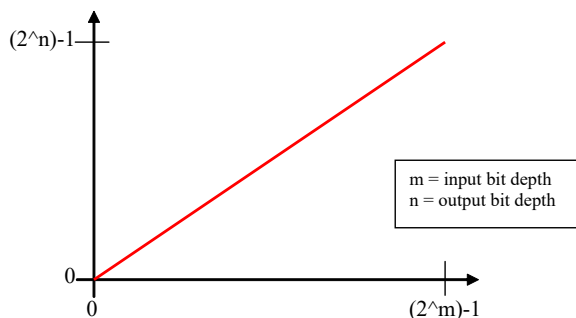

15.1. ProcessingOffset

The offset is a relative value added to each pixel, which leads to a behavior similar to a brightness controller. A relative offset means, that e. g. 0.5 adds half of the total brightness to each pixel. In absolute numbers when using 8 bit/pixel, 128 is added to each pixel ($0.5 \times 255 = 127.5$). If you rather want to add an absolute value to each pixel do the following calculation: e. g. add -51 to an 8 bit/pixel offset = $-51 / 255 = -0.2$. Figure 15.2 shows an example of an offset.

Figure 15.2. Lookup Table Processing: Offset

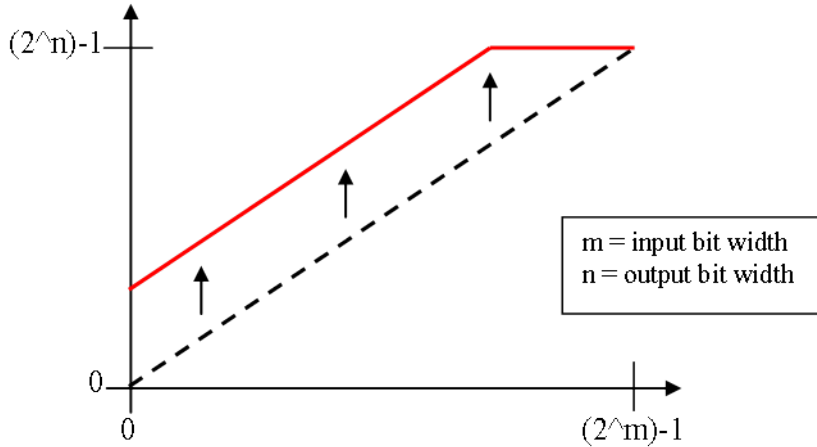

Table 15.1. Parameter properties of ProcessingOffset

Property	Value
Name	ProcessingOffset
Display Name	Offset
Interface	IFloat
Access policy	Read/Write/Change
Visibility	Beginner
Allowed values	Minimum -1.0 Maximum 1.0 Stepsize 2.220446049250313E-16
Default value	0.0

Example 15.1. Usage of ProcessingOffset

```
/* Set */ ProcessingOffset = 0.0;
/* Get */ value_ = ProcessingOffset;
```

15.2. ProcessingGain

The gain is a multiplicative coefficient applied to each pixel, which leads to a behavior similar to a contrast controller. Each pixel value will be multiplied with the given value. For identity select value 1.0.

Figure 15.3. Lookup Table Processing: Gain

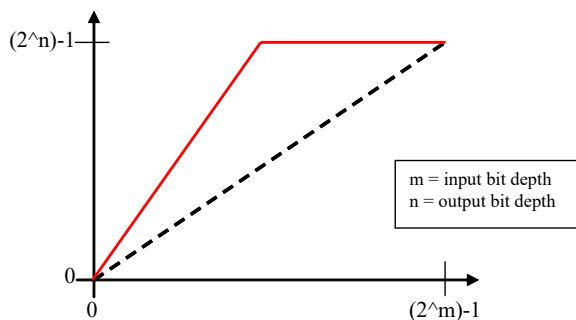

Table 15.2. Parameter properties of ProcessingGain

Property	Value
Name	ProcessingGain
Display Name	Gain
Interface	IFloat
Access policy	Read/Write/Change
Visibility	Beginner
Allowed values	Minimum 0.0 Maximum 16384.0 Stepsize 2.220446049250313E-16
Default value	1.0

Example 15.2. Usage of ProcessingGain

```
/* Set */ ProcessingGain = 1.0;
/* Get */ value_ = ProcessingGain;
```

15.3. ProcessingGamma

The gamma correction is a power-law transformation applied to each pixel. Normalized pixel values p ranging $[0, 1.0]$ transform like $p' = p^{1/\text{gamma}}$.

Figure 15.4. Lookup Table Processing: Gamma

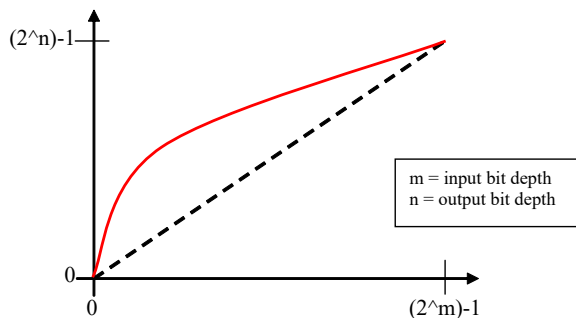

Table 15.3. Parameter properties of ProcessingGamma

Property	Value
Name	ProcessingGamma
Display Name	Gamma
Interface	IFloat
Access policy	Read/Write/Change
Visibility	Beginner
Allowed values	Minimum -1000.0 Maximum 1000.0 Stepsize 2.220446049250313E-16
Default value	1.0

Example 15.3. Usage of ProcessingGamma

```
/* Set */ ProcessingGamma = 1.0;
/* Get */ value_ = ProcessingGamma;
```

15.4. ProcessingInvert

When *ProcessingInvert* is set to **On**, the output is the negative of the input. Normalized pixel values p ranging $[0, 1.0]$ transform to $p' = 1 - p$.

Figure 15.5. Lookup Table Processing: Invert

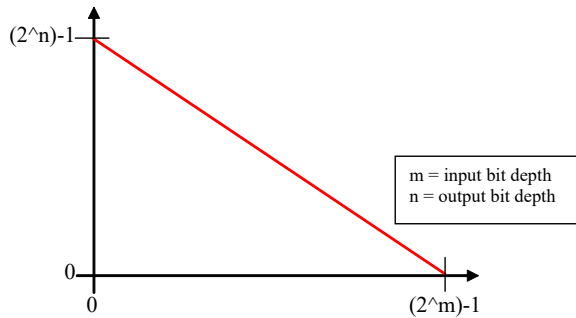

Table 15.4. Parameter properties of ProcessingInvert

Property	Value
Name	ProcessingInvert
Display Name	Invert
Interface	IEnumeration
Access policy	Read/Write/Change
Visibility	Beginner
Allowed values	On On Off Off
Default value	Off

Example 15.4. Usage of ProcessingInvert

```
/* Set */ ProcessingInvert = Off;
/* Get */ value_ = ProcessingInvert;
```

Chapter 16. OutputFormat

The following parameter can be used to configure the applet's image output format i.e. the format and bit alignment.



Automatic Adaptation of the Output Format by the GenTL Adaptor

The GenTL adaptor can automatically set the output format based on the camera settings and a given mapping table. Changing the output format of the applet might get overwritten by the GenTL adaptor on acquisition start. You can only set the output format if this automatic adaptation is disabled. See the GenTL documentation parameter **AutomaticFormatControl** for more details.

The automatic adaptation applies for parameters *PixelFormat*, *Format*, *BitAlignment* and *CustomBitShiftRight*.

Depending on the setting of GenTL interface parameter **OutputPackedFormats** the automatic adaptation will either use the same pixel format as coming from the camera or an unpacked PC output format. Changing the output format of the applet might get overwritten by the GenTL on acquisition start. You can only set the output format if this automatic adaptation is disabled. See the GenTL documentation parameter **AutomaticFormatControl** for more details.



Output Format Setting Defines GenTL Buffer Info

The parameters define the DMA output format and therefore the GenTL buffer info values to inform the consumer about the used output pixel format of the interface.

16.1. Format

Parameter *Format* is used to set and determine the output formats of the DMA channels. An output format value specifies the number of bits and the color format of the output.

This applet has an internal processing bit width of 16 bits. Any selected camera pixel format is mapped to this internal bit width. Check the camera parameter section to learn about the mapping of the camera bits to the internal bit width. For a definition on how to map the internal bits to the output bits, check parameter *BitAlignment*.

Moreover, the color converter of this applet can convert between different color formats of the input and output. Check Chapter 13, '*ColorConverter*' for more information.

This applet supports the following output formats:

- **BGR8** and **RGB8**: 24 bit BGR/RGB color format with 8 bit/component.
- **BGRa8** and **RGBa8**: Color format with 8 bit/component. Component "a" has value zero.
- **BGR10p** and **RGB10p**: 30 bit BGR/RGB color format with 10 bit/component.



30 Bit Output Format

Note that in the 30 bit output format 1 pixel and its 3 color components are distributed over multiple bytes. Also, two successive pixel might share one byte. The pixel are directly aligned in memory. Thus 8 successive color components are stored in 10 byte. The DMA transfer might be filled with random content for the last bytes.

- **BGR12p** and **RGB12p**: 36 bit BGR/RGB color format with 12 bit/component.



36 Bit Output Format

Note that in the 36 bit output format 1 pixel and its 3 color components are distributed over multiple bytes. Also, two successive pixel might share one byte. The pixel are directly aligned in memory. Thus 2 successive color components are stored in 3 byte or two pixel in 9 Byte. The DMA transfer might be filled with random content for the last bytes.

- **BGR14p** and **RGB14p**: 42 bit BGR/RGB color format with 14 bit/component.



42 Bit Output Format

Note that in the 42 bit output format 1 pixel and its 3 color components are distributed over multiple bytes. Also, two successive pixel might share one byte. The pixel are directly aligned in memory. Thus 4 successive color components are stored in 7 byte or four pixel in 21 Byte. The DMA transfer might be filled with random content for the last bytes.

- **BGR16** and **RGB16**: 48 bit BGR/RGB color format with 16 bit/component.



BGR vs. RGB Memory Alignment

Note that the color components are either written to the PC buffer in the common blue, green, red (BGR) or red, green, blue order. So either the blue or red color component is at the lower memory address.

- **Mono8**: 8 bit grayscale format
- **Mono10p**: 10 bit grayscale format



10 Bit Output Format

Note that in the 10 bit output format 1 pixel is distributed over more than one byte. Also, two successive pixel share one byte. The pixel are directly aligned in memory. Thus 8 successive pixel are stored in 10 byte. The DMA transfer might be filled with random content for the last bytes.

- **Mono12p**: 12 bit grayscale format



12 Bit Output Format

Note that in the 12 bit output format 1 pixel is distributed over more than one byte. Also, two successive pixel share the same byte. The pixel are directly aligned in memory. Thus 2 successive pixel are stored in 3 byte. The DMA transfer might be filled with random content for the last bytes.

- **Mono14p**: 14 bit grayscale format



14 Bit Output Format

Note that in the 14 bit output format 1 pixel is distributed over more than one byte. Also, two successive pixel share the same byte. The pixel are directly aligned in memory. Thus 12 successive pixel are stored in 21 byte. The DMA transfer might be filled with random content for the last bytes.

- **Mono16**: 16 bit grayscale format



DMA Bandwidth

Keep in mind that for the 16 bit output mode, the DMA bandwidth might not be sufficient to process the camera input data. Check Section 1.2, 'Bandwidth' for more information.

- **BayerGR8, BayerRG8, BayerGB8 and BayerBG8:** 8 bit Bayer format Green-followed-by-Red, Red-followed-by-Green, Green-followed-by-Blue and Blue-followed-by-Green.
- **BayerGR10p, BayerRG10p, BayerGB10p and BayerBG10p:** 10 bit Bayer format Green-followed-by-Red, Red-followed-by-Green, Green-followed-by-Blue and Blue-followed-by-Green.



10 Bit Output Format

Note that in the 10 bit output format 1 pixel is distributed over more than one byte. Also, two successive pixel share one byte. The pixel are directly aligned in memory. Thus 8 successive pixel are stored in 10 byte. The DMA transfer might be filled with random content for the last bytes.

- **BayerGR12p, BayerRG12p, BayerGB12p and BayerBG12p:** 12 bit Bayer format Green-followed-by-Red, Red-followed-by-Green, Green-followed-by-Blue and Blue-followed-by-Green.



12 Bit Output Format

Note that in the 12 bit output format 1 pixel is distributed over more than one byte. Also, two successive pixel share the same byte. The pixel are directly aligned in memory. Thus 2 successive pixel are stored in 3 byte. The DMA transfer might be filled with random content for the last bytes.

- **BayerGR14p, BayerRG14p, BayerGB14p and BayerBG14p:** 14 bit Bayer format Green-followed-by-Red, Red-followed-by-Green, Green-followed-by-Blue and Blue-followed-by-Green.



14 Bit Output Format

Note that in the 14 bit output format 1 pixel is distributed over more than one byte. Also, two successive pixel share the same byte. The pixel are directly aligned in memory. Thus 12 successive pixel are stored in 21 byte. The DMA transfer might be filled with random content for the last bytes.

- **BayerGR16, BayerRG16, BayerGB16 and BayerBG16:** 16 bit Bayer format Green-followed-by-Red, Red-followed-by-Green, Green-followed-by-Blue and Blue-followed-by-Green.



DMA Bandwidth

Keep in mind that for the 16 bit output mode, the DMA bandwidth might not be sufficient to process the camera input data. Check Section 1.2, 'Bandwidth' for more information.

- **YCbCr422_8:** YUV 422 output in 8 bit per component.

Table 16.1. Parameter properties of Format

Property	Value																																				
Name	Format																																				
Display Name	Output Format																																				
Interface	IEnumeration																																				
Access policy	Read/Write																																				
Visibility	Beginner																																				
Allowed values	<table border="0"> <tr><td>Mono8</td><td>Mono 8</td></tr> <tr><td>Mono10p</td><td>Mono 10p</td></tr> <tr><td>Mono12p</td><td>Mono 12p</td></tr> <tr><td>Mono14p</td><td>Mono 14p</td></tr> <tr><td>Mono16</td><td>Mono 16</td></tr> <tr><td>BGR8</td><td>BGR 8bit</td></tr> <tr><td>BGR10p</td><td>BGR 10bit</td></tr> <tr><td>BGR12p</td><td>BGR 12bit</td></tr> <tr><td>BGR14p</td><td>BGR 14p</td></tr> <tr><td>BGR16</td><td>BGR 16bit</td></tr> <tr><td>RGB8</td><td>RGB 8</td></tr> <tr><td>RGB10p</td><td>RGB 10p</td></tr> <tr><td>RGB12p</td><td>RGB 12p</td></tr> <tr><td>RGB14p</td><td>RGB 14p</td></tr> <tr><td>RGB16</td><td>RGB 16</td></tr> <tr><td>BGRa8</td><td>BGRA 8</td></tr> <tr><td>RGBa8</td><td>RGBA 8</td></tr> <tr><td>YCbCr422_8</td><td>YCbCr422_8</td></tr> </table>	Mono8	Mono 8	Mono10p	Mono 10p	Mono12p	Mono 12p	Mono14p	Mono 14p	Mono16	Mono 16	BGR8	BGR 8bit	BGR10p	BGR 10bit	BGR12p	BGR 12bit	BGR14p	BGR 14p	BGR16	BGR 16bit	RGB8	RGB 8	RGB10p	RGB 10p	RGB12p	RGB 12p	RGB14p	RGB 14p	RGB16	RGB 16	BGRa8	BGRA 8	RGBa8	RGBA 8	YCbCr422_8	YCbCr422_8
Mono8	Mono 8																																				
Mono10p	Mono 10p																																				
Mono12p	Mono 12p																																				
Mono14p	Mono 14p																																				
Mono16	Mono 16																																				
BGR8	BGR 8bit																																				
BGR10p	BGR 10bit																																				
BGR12p	BGR 12bit																																				
BGR14p	BGR 14p																																				
BGR16	BGR 16bit																																				
RGB8	RGB 8																																				
RGB10p	RGB 10p																																				
RGB12p	RGB 12p																																				
RGB14p	RGB 14p																																				
RGB16	RGB 16																																				
BGRa8	BGRA 8																																				
RGBa8	RGBA 8																																				
YCbCr422_8	YCbCr422_8																																				
Default value	Mono8																																				

Example 16.1. Usage of Format

```
/* Set */ Format = Mono8;
/* Get */ value_ = Format;
```

16.2. BitAlignment

The bit alignment is used to map the pixel bits of the internal processing with a depth of 16 bit to the configured DMA output bit depth defined by parameter *Format*.

You can select three different modes: Left aligned, right aligned and a custom shift mode. If you select left aligned, the applet will map the upper bits of the internal processing bit width to the available output bits. If you select right aligned, the applet will map the lower bits of the internal processing bit width to the available output bits. If you want to define a custom bit shift, you'll need to set the parameter to *CustomBitShift* and use parameter *CustomBitShiftRight* to define the bit shift.

Keep in mind that the internal processing bit width has nothing to do with the camera pixel format. Check the camera parameter section to learn about the mapping of the camera bits to the internal bit width.

Table 16.2. Parameter properties of BitAlignment

Property	Value
Name	BitAlignment
Display Name	Bit Alignment
Interface	IEnumeration
Access policy	Read/Write/Change
Visibility	Beginner
Allowed values	LeftAligned Left Aligned RightAligned Right Aligned CustomBitShift Custom Bit Shift
Default value	LeftAligned

Example 16.2. Usage of BitAlignment

```
/* Set */ BitAlignment = LeftAligned;
/* Get */ value_ = BitAlignment;
```

16.3. PixelDepth

The pixel depth read-only parameter is used to determine the number of bits used to process a pixel in the applet. It represents the internal bit width.

Table 16.3. Parameter properties of PixelDepth

Property	Value
Name	PixelDepth
Display Name	Pixel Depth
Interface	IInteger
Access policy	Read-Only
Visibility	Beginner
Allowed values	Minimum 0 Maximum 128 Stepsize 1
Unit of measure	bit

Example 16.3. Usage of PixelDepth

```
/* Get */ value_ = PixelDepth;
```

16.4. CustomBitShiftRight

This parameter can only be used if parameter *BitAlignment* is set to **CustomBitShift**. If it is enabled, you can define a custom right bit shift value for the DMA output of the frame grabber. A shift of 0 means that the most significant bits (MSB) of the internal processing bit width are mapped to the output MSB. For example, if the applet has an internal processing bit width of 12 bit and you select a 10 bit output, the upper 10 bits are mapped to the output. If you select however a bit width of two, the lower 10 bits are mapped to the output. Note that this applet has an internal bit width of 16 bits.

Table 16.4. Parameter properties of CustomBitShiftRight

Property	Value
Name	CustomBitShiftRight
Display Name	Bit Shift Right
Interface	IInteger
Access policy	Read/Write/Change
Visibility	Beginner
Allowed values	Minimum 0 Maximum 15 Stepsize 1
Default value	0
Unit of measure	bit

Example 16.4. Usage of CustomBitShiftRight

```
/* Set */ CustomBitShiftRight = 0;
/* Get */ value_ = CustomBitShiftRight;
```

Chapter 17. Revision History

Revision history of AcquisitionApplets releases.

Applet Version	Release Date	Change Log	Delivered with
1.0.3.0	06 September 2021	Initial version of this applet.	Framegrabber SDK 5.9
2.0.4.0	01 March 2022	Applets built anew for release without functional changes of the applets.	Framegrabber SDK 5.10
2.3.8.0	30 June 2023	<ul style="list-style-type: none">• Frame-IDs are now generated for DMA transfer and for GenTL buffer info.• Updated the overflow module: Changed the behavior in overflow conditions and added frame-ID to overflow event.• Extended the overflow event by the sequence end flag to indicate the end of an image trigger multi buffer sequence.• The CXP-12 frame grabber now supports stream packet sizes of maximum 16 KB.• Bugfixes.	Framegrabber SDK 5.11
2.4.8.0	22 December 2023	<p>• CoaXPress trigger packets updated to CoaXPress pylon 7.5.0 & 2.1: The applet now supports sending the CXP Framegrabber SDK LinkTrigger0, LinkTrigger1, LinkTrigger2 and LinkTrigger3. For each link trigger, an individual source can be selected. By default, LinkTrigger0 is the rising edge of the trigger source and LinkTrigger1 is the falling edge of the trigger, which usually represents the exposure time. The default setting is equal to previous versions. Thus, the applet is fully compatible to CXP 1.1 and 2.0. LinkTrigger2 and LinkTrigger3 are not used by default.</p> <p>The parameters <code>CxpTriggerPacketMode</code> (<code>CxpTriggerPacketMode</code>), <code>TriggerCameraSource</code> (<code>TriggerCameraSource</code>) and <code>TriggerCameraPolarity</code> (<code>TriggerCameraPolarity</code>) became legacy.</p> <ul style="list-style-type: none">• Bugfixes.	Framegrabber SDK 5.11.2

17.1. Fixed Issues

17.1.1. Fixed in Version 2.4.8.0

- Before fixing this issue, when image mirroring was activated in line applets, (i.e. *VantagePoint* = TopRight or BottomRight), the actual maximum image width could have been less than documented and depended on the applet and the used pixel format. This has been fixed. (Ticket-ID: 280289)

17.1.2. Fixed in Version 2.3.8.0

- The following CXP status parameters did not work correctly and have been fixed:
 - *SystemmonitorUsedCxpConnections*
 - *PacketTagErrorCount*
 - *CorrectedErrorCount*
 - *UncorrectedErrorCount*
 - *SystemmonitorPacketbufferOverflowCount*
 - *SystemmonitorPacketbufferOverflowSource*
 - *SystemmonitorCxpImageLineMode*
 - **FG_TRIGGER_EVENT_COUNT**
 - **FG_TRIGGER_ACKNOWLEDGEMENT_COUNT**
 - **FG_TRIGGER_WAVE_VIOLATION**
- The GenICam naming was adjusted in line scan applets to remove names that were not adhering to the GenICam standard. The **SendSoftwareTrigger** as well as **SignalAnalyzerClear** was changed to an **iCommand** (used to be an enumeration). Some content of tooltips and description has been corrected accordingly. (Ticket-IDs: 256285 & 271274)
- Fixed period calculation in module Signal Analyzer. The value was wrong by a factor of 2.5. (Ticket-ID: 274220)

17.1.3. Fixed in Version 2.0.4.0

Bitrate switching has been fixed. Prior to fixing this issue, switching the bitrate of a CXP link could put your frame grabber into a failure state. This has been fixed.

17.2. Known Issues

- In rare cases, loading an applet can fail with the error message “Fg_init(...) : -2050 (Design is invalid)”. In this case, re-load the applet and contact the Basler Support [<https://www.baslerweb.com/en/sales-support/support-contact/>]. (Ticket-ID: 259458)

Glossary

Area of Interest (AOI)	See Region of Interest.
Board	A Basler hardware. Usually, a board is represented by a frame grabber. Boards might comprise multiple devices.
Board ID Number	An identification number of a Basler board in a PC system. The number is not fixed to a specific hardware but has to be unique in a PC system.
Camera Index	The index of a camera connected to a frame grabber. The first camera will have index zero. Mind the difference between the camera index and the frame grabber camera port. See also Camera Port.
Camera Port	The Basler frame grabber connectors for cameras are called camera ports. They are numbered {0, 1, 2, ...} or enumerated {A, B, C, ...}. Depending on the interface one camera could be connected to multiple camera ports. Also, multiple cameras could be connected to one camera port.
Camera Tap	See Tap.
Device	A board can consist of multiple devices. Devices are numbered. The first device usually has number one.
Direct Memory Access (DMA)	<p>A DMA transfer allows hardware subsystems within the computer to access the system memory independently of the central processing unit (CPU).</p> <p>Basler uses DMAs for data transfer such as image data between a board e.g. a frame grabber and a PC. Data transfers can be established in multiple directions i.e. from a frame grabber to the PC (download) and from the PC to a frame grabber (upload). Multiple DMA channels may exist for one board. Control and configuration data usually do not use DMA channels.</p>
DMA Channel	See DMA Index.
DMA Index	The index of a DMA transfer channel. See also Direct Memory Access.
Event	<p>In programming or runtime environments, a callback function is a piece of executable code that is passed as an argument, which is expected to call back (execute) exactly that time an event is triggered. These events are not related to a special camera functionality and based on frame grabber internal functionality.</p> <p>Basler uses hardware interrupts for the event transfer and processing is absolutely optimized for low latency. These interrupts are only produced by the frame grabber if an event is registered and activated by software. If an event is fired at a very high frequency this may influence the system performance.</p> <p>For example these events can be used to check the reliability between a frame trigger input and the resulting and expected camera frame.</p> <p>The Basler Framegrabber SDK enables an application to get these event notifications about certain state changes at the data flow from camera to RAM and the image and trigger processing as well. Please consult the Basler Framegrabber SDK documentation for more details concerning the implementation of this functionality. Some events are enabled to produce additional data, which is described for the event itself.</p>

Frame Grabber	Usually a PC hardware using PCI express to interface the camera and grab camera images. The frame grabber will grab, buffer, pre-process and forward the images to the PC memory. Moreover, the frame grabber performs the trigger signal processing to trigger the camera, external lights and controllers. On V-series frame grabber custom processing can be implemented using VisualApplets. See also Direct Memory Access, Interface Card, VisualApplets.
GenICam	Generic Interface for Cameras is a generic programming interface for machine vision (industrial) cameras.
GenTL	GenICam Transport Layer. This is the transport layer interface for enumerating cameras, grabbing images from the camera, and moving them to the user application.
Interface Card	Usually a PC hardware using PCI express to interface the camera and grab camera images. The interface card will grab, buffer and forward the images to the PC memory. Moreover, the interface card performs the trigger signal processing to trigger the camera, external lights and controllers. See also Direct Memory Access, Frame Grabber.
Port	See Camera Port.
Process	An image or signal data processing block. A process can include one or more cameras, one or more DMA channels and modules.
Region of Interest (ROI)	Represents a part of a frame. Mostly rectangular and within the original image boundaries. Defined by source coordinates and its dimension. The frame grabber cuts the region of interest from the camera image. A region of interest might reduce or increase the required bandwidth and the corresponding image dimension.
Sensor Tap	See Tap.
Software Callback	See Event.
Tap	Some cameras have multiple taps. This means, they can acquire or transfer more than one pixel at a time which increases the camera's acquisition speed. The camera sensor tap readout order varies. Some cameras read the pixels interlaced using multiple taps, while some cameras read the pixel simultaneously from different locations on the sensor. The reconstruction of the frame is called sensor readout correction. The Camera Link interface is also using multiple taps for image transfer to increase the bandwidth. These taps are independent from the sensor taps.
Trigger	In machine vision and image processing, a trigger is an event which causes an action. This can be for example the initiation of a new line or frame acquisition, the control of external hardware such as flash lights or actions by a software applications. Trigger events can be initiated by external sources, an internal frequency generator (timer) or software applications. The event itself is mostly based on a rising or falling edge of a electrical signal.
Trigger Input	A logic input of a trigger IO. The first input has index 0. Check mapping of input pins to logic inputs in the hardware documentation.
Trigger Output	A logic output of a trigger IO. The first output has index 1. Please check the mapping of output pins to logic outputs in the hardware documentation. The electrical characteristics and specification can be found related to the selected or used trigger board/connector.
Trigger Reliability	See Event.

User Interrupt

See Event.

VisualApplets

Simple programming of FPGA-based image processing devices.

VisualApplets enables access to the FPGA processors in the image processing hardware, such as frame grabbers, industrial cameras and image processing devices, to implement individual image processing applications.

Index

A

Area of Interest, 12

B

Bandwidth, 3

BitAlignment, 88

C

Camera, 9

 Events, 9

 Format, 5

 Interface, 4, 9

Camera Trigger Source, 16, 22, 25, 25

Camera::Events, 9

CoaXPress, 5

Color Converter, 73

CorrectedErrorCount, 6

CustomBitShiftRight, 89

CustomSignalEvent0, 29

CustomSignalEvent0Polarity, 26

CustomSignalEvent0Source, 25

CustomSignalEvent1, 29

CustomSignalEvent1Polarity, 28

CustomSignalEvent1Source, 27

CxpLinkTrigger0Source, 16

CxpLinkTrigger0SourceEdge, 17

CxpLinkTrigger1Source, 18

CxpLinkTrigger1SourceEdge, 18

CxpLinkTrigger2Source, 19

CxpLinkTrigger2SourceEdge, 20

CxpLinkTrigger3Source, 20

CxpLinkTrigger3SourceEdge, 21

D

Debugging, 58

Digital I/O, 16, 16

Digital I/O::Camera, 16

Digital I/O::Event Source, 25

Digital I/O::Events, 29

Digital I/O::GPI, 25

Digital I/O::GPO, 22

DigitalInput, 25

E

Events

 Camera, 9

 Overflow, 67

 Trigger, 29

ExSyncOn, 31

ExSyncPolarity, 48

F

Features, 1

FillLevel, 64

FlashOn, 52
FlashPolarity, 55
Format, 85, 85
Frame ID, 4
FrameTransferEnd, 9
FrameTransferStart, 9

H

Height, 14

I

Image Select, 69
Image Selector, 69
Image Transfer, 4
Image Trigger / Flash, 50
Image Trigger / Flash::Image Trigger Input, 53
Image Trigger / Flash::Image Trigger Input::Flash, 55
Image Trigger / Flash::Image Trigger Input::Software Trigger, 56
ImageSelect, 69
ImageSelectPeriod, 69
ImageTriggerAsyncHeight, 52
ImageTriggerDebouncing, 54
ImageTriggerGateDelay, 54
ImageTriggerInputPolarity, 54
ImageTriggerInputSource, 53
ImageTriggerIsBusy, 52
ImageTriggerMode, 51
ImageTriggerOn, 51

L

Line Trigger / ExSync, 30
Line Trigger / ExSync::ExSync Output, 46
Line Trigger / ExSync::Line Trigger Input, 32
Line Trigger / ExSync::Line Trigger Input::Downscale, 35
Line Trigger / ExSync::Shaft Encoder A/B Filter, 36
Line0FallingEdge, 29
Line0RisingEdge, 29
LineDownscale, 35
LineDownscaleInit, 36
LineExposure, 48
LinePeriod, 47
LineTransferEnd, 9
LineTransferStart, 9
LineTriggerDebouncing, 34
LineTriggerDelay, 49
LineTriggerInPolarity, 34
LineTriggerInSource, 33
LineTriggerMode, 30
Lookup Table, 74, 74
Lookup Table::Applet Properties, 79
LutCustomFile, 77
LutEnable, 74
LutImplementationType, 79
LutInputPixelBitDepth, 79
LutOutputPixelBitDepth, 80
LutSaveFile, 79
LutType, 74
LutValue, 75

LutValueBlue, 76
LutValueGreen, 76
LutValueRed, 76

O

OffsetX, 14
OffsetY, 15
Output Format, 85
Overflow, 64, 64, 65, 68
 Events, 67
Overflow::Events, 67
OverflowEventSelect, 66
OverflowOffThreshold, 65
OverflowOnThreshold, 66
OverflowSyncOnThreshold, 66

P

PacketTagErrorCount, 6
PC Interface, 4
Pixel Format, 5
PixelDepth, 89
PixelFormat, 5
Processing, 81
ProcessingGain, 82
ProcessingGamma, 83
ProcessingInvert, 84
ProcessingOffset, 81
Processor, 81

R

Region of Interest, 12
ROI, 12

S

ScalingFactorBlue, 71
ScalingFactorGreen, 71
ScalingFactorRed, 71
SendSoftwareTrigger, 56
Sensor Geometry, 10, 10
SensorHeight, 11
SensorWidth, 10
SetSoftwareTrigger, 56
ShaftEncoderCompensationCount, 41
ShaftEncoderCompensationEnable, 40
ShaftEncoderInputSource, 38
ShaftEncoderLeading, 39
ShaftEncoderMode, 37
ShaftEncoderOn, 37
Signal Analyzer, 58, 58
SignalAnalyzer0CurrentPeriod, 60
SignalAnalyzer0MaxPeriod, 60
SignalAnalyzer0MinPeriod, 61
SignalAnalyzer0Polarity, 59
SignalAnalyzer0PulseCount, 61
SignalAnalyzer0Source, 58
SignalAnalyzer1CurrentPeriod, 60
SignalAnalyzer1MaxPeriod, 60
SignalAnalyzer1MinPeriod, 61

SignalAnalyzer1Polarity, 59
SignalAnalyzer1PulseCount, 61
SignalAnalyzer1Source, 58
SignalAnalyzerClear, 62
SignalAnalyzerPulseCountDifference, 62
Specifications, 1
StrobePulseDelay, 55
SystemmonitorCxpImageLineMode, 8
SystemmonitorPacketbufferOverflowCount, 7
SystemmonitorPacketbufferOverflowSource, 8
SystemmonitorUsedCxpConnections, 6

T

Trigger
 Digital Input, 25
 Events, 29
 Input, 25
TriggerFrontOutGPO0Polarity, 24
TriggerFrontOutGPO1Polarity, 24
TriggerOutFrontGPO0Source, 23
TriggerOutFrontGPO1Source, 23
TriggerOutGPO0Polarity, 23
TriggerOutGPO0Source, 22
TriggerOutGPO1Polarity, 23
TriggerOutGPO1Source, 22
TriggerOutGPO2Polarity, 23
TriggerOutGPO2Source, 22
TriggerOutGPO3Polarity, 23
TriggerOutGPO3Source, 22
TriggerOutGPO4Polarity, 23
TriggerOutGPO4Source, 22
TriggerOutGPO5Polarity, 23
TriggerOutGPO5Source, 22
TriggerOutGPO6Polarity, 23
TriggerOutGPO6Source, 22
TriggerOutGPO7Polarity, 23
TriggerOutGPO7Source, 22

U

UncorrectedErrorCount, 7

V

VantagePoint, 10

W

White Balance, 71, 71
Width, 13